

MANDELLI 1953

Design
in your
hands

2023 edition

Design in your hands

Ogni azienda nasce da un sogno e quello del fondatore di Mandelli Maniglie aveva il colore dell'oro: l'ottone. Correva l'anno 1953. Passione per la bellezza e ingegno che genera innovazione: il saper fare consiste in questo ed è un valore in cui MANDELLI1953 si riconosce da sempre.

Every business rises from a dream and Mandelli's founder had a golden-coloured dream about brass. That was back in 1953. The passion for beauty and the ingenuity that drives innovation is what creates expertise, something that has always been a feature of MANDELLI1953.

M

1953

indice / index

Mandelli 1953	6
Atelier	20
Archivi / Archives	32
Designers	36
Finiture / Finishes	46
Collezione / Collection	50
Complementi / Complements	186
Accessori / Accessories	208
Info tecniche / Technical Data	216
Panoramica / Overview	266



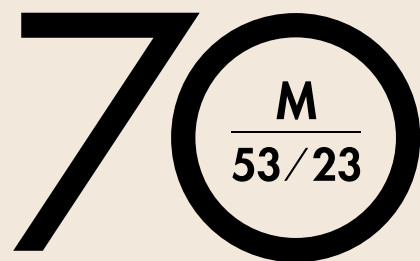

Da settant'anni progettiamo e realizziamo maniglie in ottone. Eccellente qualità, creatività e continua ricerca per un prodotto altamente affidabile di elevato valore estetico, interamente lavorato in Italia.

Since seventy years we have designed and manufactured brass handles. Excellent quality, creativity and continuous research for a highly reliable product of aesthetic value, entirely processed in Italy.



Dalla scelta dell'ottone, italiano e di primissima qualità, fino all'imballaggio della maniglia finita, l'intera produzione viene seguita con la massima cura e dedizione in Italia, nel distretto della Brianza. Per questo MANDELLI1953 marchio tutti i suoi prodotti con il logo "100% MADE IN ITALY". Quello che il marchio MANDELLI1953 esporta nel mondo non è solo un prodotto d'eccellenza ma un'intera cultura dell'oggetto realizzato ad arte, del saper fare italiano e dell'alta artigianalità, derivata da antiche tradizioni che negli anni hanno saputo rinnovarsi e utilizzare le migliori tecnologie.

From the brass of the highest quality and totally Italian, through to the packaging, the whole production process is characterised by great care and attention to detail, here in the Brianza district of Italy. MANDELLI1953 marks all its products "100% MADE IN ITALY". Not only is the product MANDELLI1953 exports a mark of excellence, but represents the culture, art and manufacturing ability from its Italian traditions, heritage and craftsmanship, that, through all these years, has been able to improve using the finest technologies.



Settant'anni di storia sono un patrimonio di sapienza artigianale prezioso, cui si aggiungono dedizione, abilità manuale e tecnologia industriale per spingere costantemente l'azienda a produrre nuovi modelli tecnologicamente all'avanguardia con finiture innovative e sostenibili. La continua attività di ricerca da parte del Centro Ricerca e Sviluppo è mirata a coniugare forma e funzione senza compromessi, ponendo MANDELLI1953 tra le aziende leader nel settore, su territorio nazionale e internazionale.

Seventy years in the business have given the company great experience in the artisanal tradition, improving dedication, manual skills and industrial technology, this has provided the impetus for a constant flow of highly-advanced models with innovative and sustainable finishes. Constant work in Research and Development department has the target to create the best combinations of form and function, without compromising quality. This makes MANDELLI1953 one of the leading companies in this field, worldwide.



La qualità per MANDELLI1953 si riferisce, prima ancora che alle indiscutibili caratteristiche tecnologiche dei suoi prodotti, a un insieme di atti, un misto di testardaggine, strategia della pazienza e passione per i dettagli. Tutte le maniglie vengono realizzate all'interno dell'azienda utilizzando unicamente ottone italiano certificato, cui viene data forma tramite forgiatura, tornitura e pressofusione, smerigliatura, vibratura, lucidatura e satinatura – trattamenti galvanici e trattamenti di metallizzazione (PVD) e verniciature. Inflexibile l'attenzione per il ben fatto: sono sempre i particolari a fare la differenza tra un buon prodotto e un manufatto di livello superiore, consapevolezza fondamentale dell'azienda.

MANDELLI1953 quality means a whole series of actions, stubbornness, a strategy of patience and a passion for details. All our handles are made in our factory using only certified Italian brass. This is forged, turned, die cast, grounded, vibrated, polished and satin-finished as well as being treated with galvanising and varnishing processes. The care taken over the finished product is inflexibly constant, this makes the difference between a good product and an excellent one, something that the company has always been aware of.



MANDELLI 1953 ha ottenuto presso l'Istituto IFT Rosenheim, organismo che assicura un prestigioso riconoscimento a livello europeo, le seguenti certificazioni: EN 1906 : 2010: classificazione 47-0040B, una nuova certificazione europea che testa la durata e la resistenza all'usura e alla corrosione di maniglie e pomoli, collocando i prodotti nella fascia più alta (classe 4). EN 1670 : 2007: una certificazione che colloca i prodotti MANDELLI1953 in classe 4, la più alta classe di resistenza alla corrosione (240 ore in nebbia salina).

MANDELLI1953 has received several certificates from the IFT Rosenheim Institute, an institution that assures European recognition: EN 1906 : 2010: class 47-0040B, a European certificate testing durability, static strength and corrosion resistance for lever handles and knobs, obtaining category of use class 4. EN 1670 : 2007: this certificate gives MANDELLI1953 the highest quality level (class 4) regarding resistance to corrosion (240 hours in salty fog chamber).

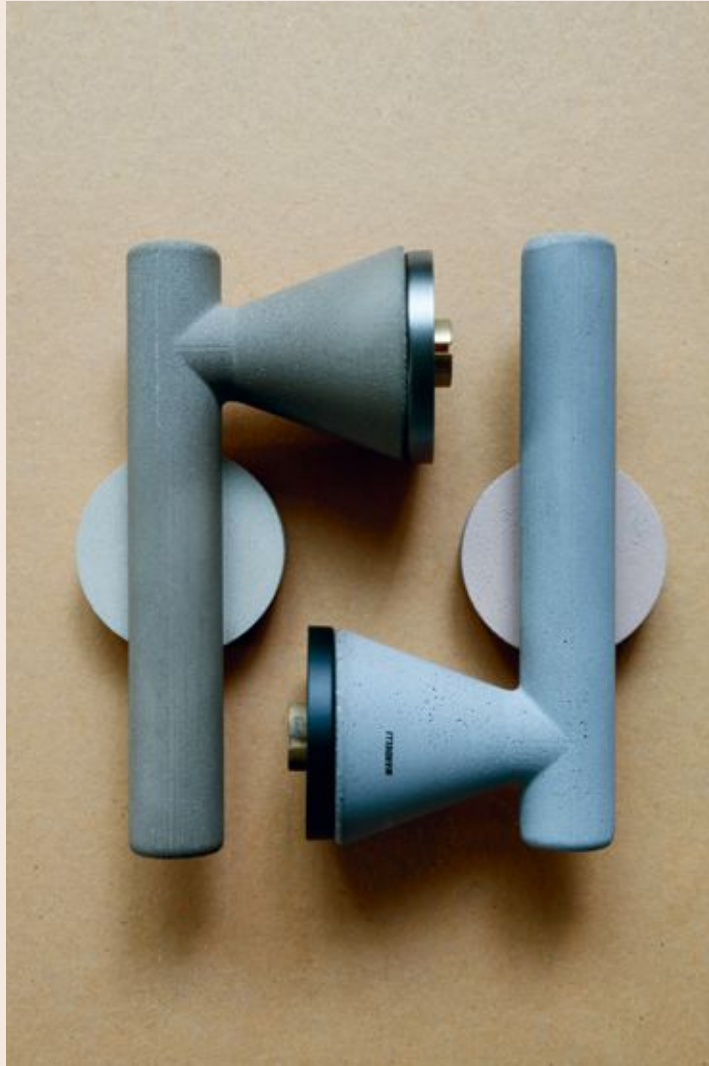

Premi. L'unione di abilità manuale e tecnologia industriale, la continua attività di ricerca mirata a coniugare forma e funzione, la collaborazione con importanti firme del panorama nazionale e internazionale: è questa la filosofia alla base di ogni progetto. Una produzione costante di nuovi modelli, sempre abbinati a finiture innovative e sostenibili, si è fatta notare, ricevendo negli anni prestigiosi riconoscimenti.

Awards. The creative mix of manual skill and industrial technology, the continue research to combine form and function, the collaboration with important designers: these are the ingredients behind each MANDELLI1953 project. A philosophy based on a constant production of new models, always combined with innovative and sustainable finishes. All this effort has been repaid receiving prestigious awards over the years.



Sono i dettagli che danno valore a porte e finestre, rivelando il carattere degli spazi che arredano: nasce *Atelier Mandelli*, dove la cura di un laboratorio artigianale e le risorse di una produzione industriale in continuo aggiornamento si uniscono per soddisfare ogni richiesta progettuale, sia in termini funzionali che estetici.

atelier

The beauty in doors and windows has to be found in details, as they reflect the character of the space they furnish. *Atelier Mandelli* brings together the care and attention of an artisanal workshop and the resources of a constantly-updated manufacturing process designed to meet the needs of any project in terms of function and aesthetic design.

atelier

Juno, Contemporary Collection
Sand

Cemento. Ricerca e sperimentazione ispirano il progetto Juno firmato Alessandro Dubini per MANDELLI1953. Il materiale costitutivo è il cemento, duro e al tempo stesso morbido, quasi vellutato al tatto. Colori ispirati alle sfumature della terra, una forma contemporanea ed essenziale per esaltare l'originale scelta del materiale, protagonista incontrastato di questo progetto. Vincitrice del premio Good Design 2017.

Concrete. Research and experiment inspire the Juno project by Alessandro Dubini for MANDELLI1953. The constitutive material used is concrete, which is hard and yet soft, almost velvet to touch. Colours are inspired by natural ones, while contemporary and clean forms emphasise the originality and unquestioned leading role of the chosen material. Good Design Award 2017 Winner.



atelier

Kuki, Contemporary Collection
Oro Lucido / Polished brass

Madreperla. Lucentezza e iridescenza fanno della materia stessa la protagonista di questa personalizzazione. Un innesto dalle svariate sfumature e colorazioni rende ogni maniglia ancora più preziosa.

Nacre. Shininess and iridescence make nacre the protagonist of this customization. A graft of various shades and colors makes each handle even more precious.

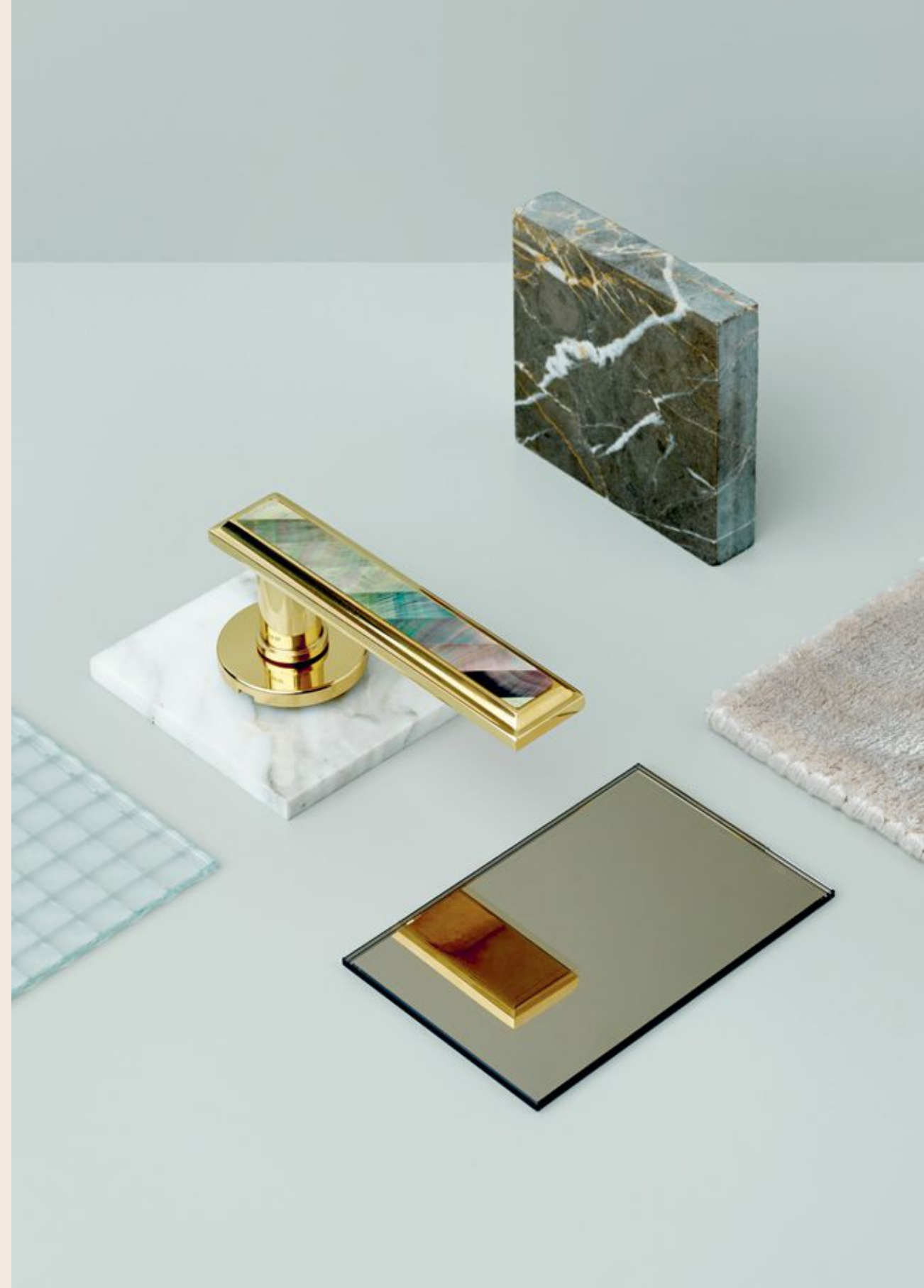

Ola, Contemporary Collection
Oro Lucido / Polished brass

Incisa. Il punto di incontro tra ornamento e design. È la possibilità di ottenere decorazioni precise sulla superficie metallica di base, l'ottone, da cui prendono forma le maniglie MANDELLI1953. La tecnica *guilloché*, realizzata da un'apposita macchina guidata manualmente, genera un preciso pattern, dove il fascino dell'artigianato e l'avanguardia tecnologica si uniscono.

Engraving. Where ornament and design meet. Detailed decoration on MANDELLI1953 handles is achieved by the use of techniques as *guilloché*, using a manually guided machine. The resulting patterns reflect both the artisan tradition and the newest technology.



atelier

Bilbao, Contemporary Collection
Cromo lucido / Polished chrome
Pelle grigio scuro / Dark grey leather

Pelle Dettaglio morbido e raffinato, per avvolgere i progetti MANDELLI1953. La pelle non poteva mancare in un Atelier, materiale ideale per essere cucito intorno ad ogni singola idea. Lavorato a mano, con esperienza artigiana e una visione ispirata alle più moderne decorazioni di interni.

Leather - Soft and refined detail, to wrap the MANDELLI1953's projects. An Atelier couldn't lack of leather, the ideal material to be sewn around every single idea. Hand made, with artisan experience and a vision, inspired by the most modern interior decorations.



atelier

Naxos, Classic Collection

Cromo lucido / Polished chrome

Marmo Nero Marquinia / Black Marquinia Marble

Marmo. Tocco di classe sempre attuale nella decorazione d'interni, il marmo è la proposta ideale per impreziosire i pezzi senza tempo della collezione MANDELLI1953. Fulcro di progetti realizzati ad hoc, suggeriti dall'eleganza e dalle proprietà uniche del Marquinia o del Calacatta. Made in Italy, come nella nostra filosofia.

Marble. Marble provides that touch of class to interiors. It is the ideal decor for timeless items in the MANDELLI1953 collection. It is the essence of customized projects suggested by the elegance and uniqueness of Marquinia and Calacatta. Rigorously made in Italy in line with our philosophy.



archivi / archives

La collezione Archivi di MANDELLI1953 è una ricerca tra architetti, designer e artisti del passato, precursori di stili e forme proiettate verso il futuro. Una raccolta di riedizioni e di progetti inediti scoperti negli archivi e proposti per la prima volta al grande pubblico. Un omaggio a tutta la creatività Made in Italy e una fonte di ispirazione per le nuove generazioni.

MANDELLI1953 Archives collection is a quest between architects, designers and artists of the past, precursors of styles and forms projected towards the future. A collection of re-editions and unpublished projects discovered in the archives and proposed for the first time to the public. A tribute to the Made in Italy creativity and a source of inspiration for the new generations.



MM80 è il secondo modello della sezione Archivi di MANDELLI1953. Disegnata da Marcello Morandini (architetto, artista, designer) nei toni netti del nero e del bianco, in armonia tra i pieni e i vuoti, è una scultura da impugnare.

MM80 is the second model in the Archives section of MANDELLI1953. Designed by Marcello Morandini (architect, artist, designer), born in black and white, made of harmony between solids and voids. It's a sculpture to be held.

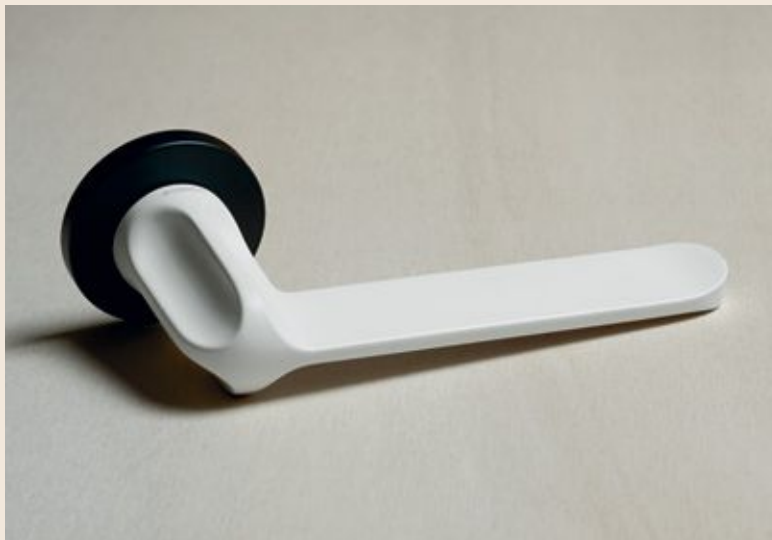

reddot winner 2021



PP33 è il nome scelto per la riedizione esclusiva di una maniglia realizzata nel 1933 dal noto architetto Piero Portaluppi. Il nuovo progetto rappresenta il primo modello di maniglia del progetto Archivi.

PP33 is the exclusive re-edition handle made in 1933 by the well-known architect Piero Portaluppi. This new project represents the first handle of the Archives project.



designers

MANDELLI1953 comprende visioni e creazioni di una selezione di autori scelti per collaborare e costruire un dialogo continuo con il mondo del design e del progetto, affinché designer contemporanei uniscano le loro maniglie ai preziosi classici ed ai modelli iconici del marchio.

MANDELLI1953 includes visions and creations by a team of authors that cooperate create a dialogue with the world of design, where the creative minds share their ideas of modern handles together with the iconic and classic MANDELLI1953's range.

designers



Pier Francesco
Arnone

Link



Dodo
Arslan

Chicane
Coupé
Less



Giuseppe
Bavuso

Aries
Virgo



Piet
Billekens

Callas
Carrè
Fenix

designers



Massimo
Cavana

Twee



Studio WA+CH
Wei Chin Cjien

Frame



Alessandro
Corina

Càlin



Alessandro
Dubini

Fusilla
Juno
K



Marcello
Morandini

MM80



Marco
Piva

Seven
Zeit

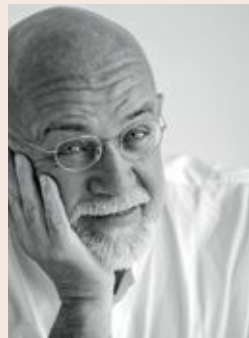

Franco
Poli

Aqualung



Piero
Portaluppi

PP33



L Ponzelli
F Valentini

40+1

finiture / finishes

L'eleganza dell'oro o la moderna brillantezza del cromo. Effetti antichizzati o raffinate satinature. Ciascun prodotto è in duro e resistente ottone, mentre un ventaglio di finiture permette poi a ciascuno di scegliere la maniglia più adatta al proprio stile.

The elegance of gold and the modern brilliance of chrome. Antique looks or sophisticated satin finishes. Every product is made of hard and resilient brass, while a whole bouquet of finishes gives everyone the handle that best suits their own style.





Fluxcoating Vitriified. Si può migliorare un materiale già eccellente? Il Centro Ricerca e Sviluppo MANDELLI1953 ne è convinto; ecco perché è stato messo a punto il sistema FLUXCOATING VITRIFIED, un rivestimento capace di migliorare le qualità estetiche dell'ottone e di mantenerle inalterate nel tempo. Il processo consiste in una serie di interventi preparatori del prodotto e nel successivo rivestimento con speciali resine. Il risultato è un'impareggiabile resistenza agli agenti atmosferici, agli urti ed alle abrasioni. Il trattamento FLUXCOATING è applicato alle speciali ed esclusive finiture di Mandelli 1953: MBR (brunito opaco), MSN (nickel satinato opaco), AB (brunito antico), 28 (argento vecchio).

Fluxcoating Vitriified. Can an already excellent material be improved? The research department of MANDELLI1953 is sure that it is possible that's why it has developed VITRIFIED FLUXCOATING system, a protective coating that enhances the quality of brass while ensuring a long life. The product goes through a series of preliminary processes, followed by the application of coatings with special resins. The result is excellent resistance to weathering, shock and abrasion, while the natural shine of polished brass remains unchanged. The FLUXCOATING treatment is available in the following finishes: MBR (matt bronze), MSN (matt satin nickel), AB (antique bronze), 28 (antique chrome).



PVD. Un ulteriore trattamento applicabile ai prodotti MANDELLI1953 è il rivestimento PVD che presenta ottimi risultati di resistenza all'abrasione, alla corrosione e tenuta del colore nel tempo, anche in ambienti esterni e pubblici. Elevate sono le caratteristiche tecniche:

- resistenza al test di stabilità alla luce solare UNI 9337 senza alcuna variazione oltre le 1000 ore;
- ottimi risultati in nebbia salina secondo le norme UNI ISO 9227 di resistenza al CASS e al AASS;
- elevata durezza superficiale ASTM B578-93 di 2600 ÷ 2800 HV (un normale riporto di cromo galvanico ha durezza 800 HV);
- perfetta aderenza al pezzo superando il test UNI ISO 4524-5;
- resistenza ad acidi e alcali come acido cloridrico, solforico, cianuri ecc.

Il trattamento PVD è disponibile per i modelli contrassegnati dal simbolo dedicato, solo sulle versioni rosetta/bocchetta e DK.

Physical Vapor Deposition. An additional treatment applied to some MANDELLI 1953 products is PVD, which name them highly resistant to abrasion, corrosion and bleaching, as well as making them suitable for outdoor and public places. The treatment achieves truly remarkable results:

- the bleaching resistance test shows no alteration even after a 1000 hour test, according to UNI 9337 norms;
- high performances for the resistance test to CASS and AAS according to UNI ISO 9227 norms in salty fog chamber;
- very high surface hardness according to ASTM B578-93 norms of 2600 ÷ 2800 HV (standard chrome plated product shows an 800 HV value);
- perfect adhesion, exceeding UNI ISO 4524-5 norms;
- resistance to acids and alkalis (hydrochloric, sulphuric, cyanide etc...). The treatment is available on models showing the PVD symbol only on the rose/escutcheon version, and with the GOLD and CHROME INOX finishes.

finiture / finishes



03
ORO
POLISHED BRASS



04
ORO SATINATO
SATIN BRASS



24KT
ORO 24KT
24KT GOLD

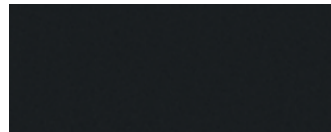

MB
NERO OPACO
MATT BLACK

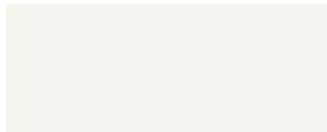

MW
BIANCO OPACO
MATT WHITE

BRONZI/BRONZES



PB|BR
BRUNITO
BRONZE



MBR
BRUNITO OPACO
MATT BRONZE



AB
BRUNITO ANTICO
ANTIQUÉ BRONZE



IB
BRONZO SCULTURA
IMPERIAL BRONZE



28
ARGENTO VECCHIO
ANTIQUÉ CHROME

finiture / finishes

GALVANICHE/GALVANIC



MSN
NICHEL SATINATO OPACO
MATT SATIN NICKEL



NL
NICHEL LUCIDO
POLISHED NICKEL



15A
GRAFITE
GRAPHITE



26D
CROMO SATINATO
SATIN CHROME



26
CROMO LUCIDO
POLISHED CHROME

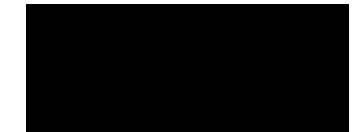

BP
NERO PERLA
BLACK PEARL



RG
ORO ROSA
ROSE GOLD

PVD



PVD
ORO LUCIDO
POLISHED BRASS



PVD
ORO SATINATO
SATIN BRASS

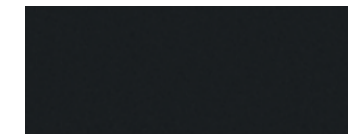

PVD
NERO OPACO
MATT BLACK



PVD
INOX LUCIDO
POLISHED INOX



PVD
INOX SATINATO
SATIN INOX

finiture / finishes

CEMENTO/CONCRETE



CENERE
ASH

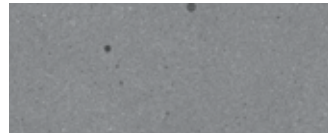

GRAFITE
GRAPHITE



TORTORA
DOVE



SABBIA
SAND



CIPRIA
BLUSH

PELLE/LEATHER

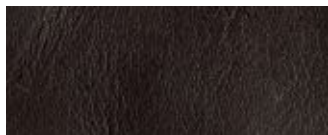

60
MARRONE SCURO
DARK BROWN



42
GRIGIO SCURO
DARK GREY



49
TORTORA
DOVE



15
CUOIO NATURALE
NATURAL LEATHER

finiture / finishes

MARMO/MARBLE

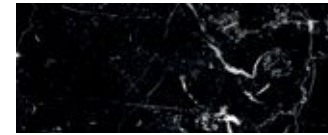

NERO MARQUINA
BLACK MARQUINA



BIANCO CALACATTA
WHITE CALACATTA

CERAMICA/CERAMIC

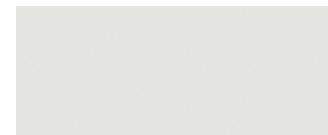

CERAMICA BIANCA
WHITE CERAMIC

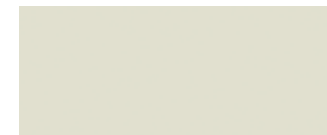

CERAMICA AVORIO
IVORY CERAMIC

collezione / collection

Il gusto eterno della tradizione, abbinato ad un'alta sapienza artigianale, fa di queste maniglie una collezione progettata per essere interprete dello stile e del design più moderno. Un irresistibile mix di stupefacente creatività e rigore funzionale.

The eternal taste of tradition, combined to high craftsmanship, makes these handles a collection designed to be interpreted in the spirit of the most modern trends in furnishing styles, in an irresistible mix of amazing creativity and functional rigour.

■ 1831	40+1	56	■ 1291	fan	88
● 451	ande	58	■ 1601	fenix	90
● 1791	aqualung	60	● 721	filo	92
● 3191	ara	62	● ■ 1871	frame	94
● 1941	aries	64	● 1731	fusilla	96
■ 1631	astrid	66	● 1421	gou	98
● 1511	aurora	68	● 1751	grint	100
● 1671	bilbao	70	● 1341	hartù	102
● 1991	câlin	72	● 1081	isi	104
● 1611	callas	74	■ 1371	jet	106
■ 1620	carré	76	● 8021	juno	108
● 1984	chrono k	78	■ 1950	K	110
● 1981	chrono h	80	■ 1461	kiri	112
● 1641	cocò	82	● 1741	kuki	114
● 1971	coupé	84	■ 1681	lario	116
● 641	doge	86	● 1091	led	118

■ 1171	life	120	● 691	rondò	152
■ 1031	link	122	■ 1761	seven	154
● 1021	lord	124	● 531	sevilla	156
● 1201	melody	126	● S91	special	158
● 1131	mitos	128	● 731	spin	160
● 1921	MM80	130	● S101	start	162
● 771	nadir	132	■ 1161	telis	164
● 8011	naxos	134	● 461	totem	166
● 1211	norma	136	● 361	tuc	168
■ 1501	nuria	138	■ 1691	twee	170
● 1071	ola	140	■ 1651	virgo	172
● 8001	paros	142	● 1301	zante	174
■ 1251	piramid	144	■ 1721	zeit	176
● 981	plissé	146	● 711	zen	178
● 1801	PP33	148	● 381	zoe	180
● 1201	river	150	● 351	zoom	182

Abbina la tua maniglia con/Match you handle with:

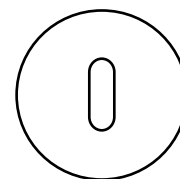
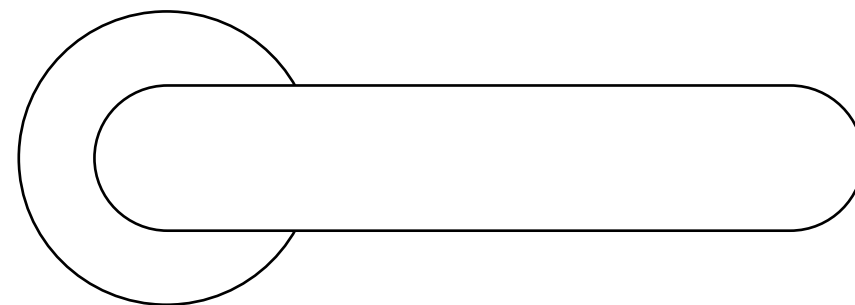

bocchetta patent
patent escutcheon

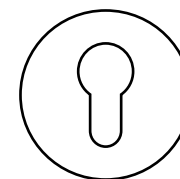

bocchetta cilindro
cylinder escutcheon

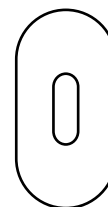

bocchetta stretta
tight escutcheon

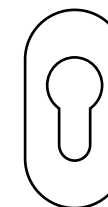

bocchetta stretta cilindro
cylinder tight escutcheon

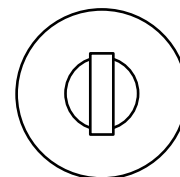

nottolino
thumb turn

40+1

design Lorenzo Ponzelli e Francesco Valentini



26D Cromo satinato
Polished chrome



15A Grafite
Graphite



MSN Nickel satinato opaco
Matt satin nickel



NL Nickel lucido
Polished nickel



PB Nero perla
Black pearl

collezione / collection

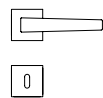

1831 con rosetta
on rose



1832/DK martellina
drehkipp system



ande



03 Oro lucido
Polished brass



04 Oro satinato
Satin brass



26 Cromo lucido
Polished chrome



26D Cromo satinato
Satin chrome



PB/BR Brunito
Bronze



MBR Brunito opaco
Matt bronze

collezione / collection

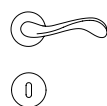

451 con rosetta
on rose

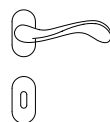

451/BS con rosetta stretta
on tight rose



452/DK martellina
drehkipp system

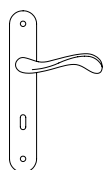

450 con piastra
on back plate

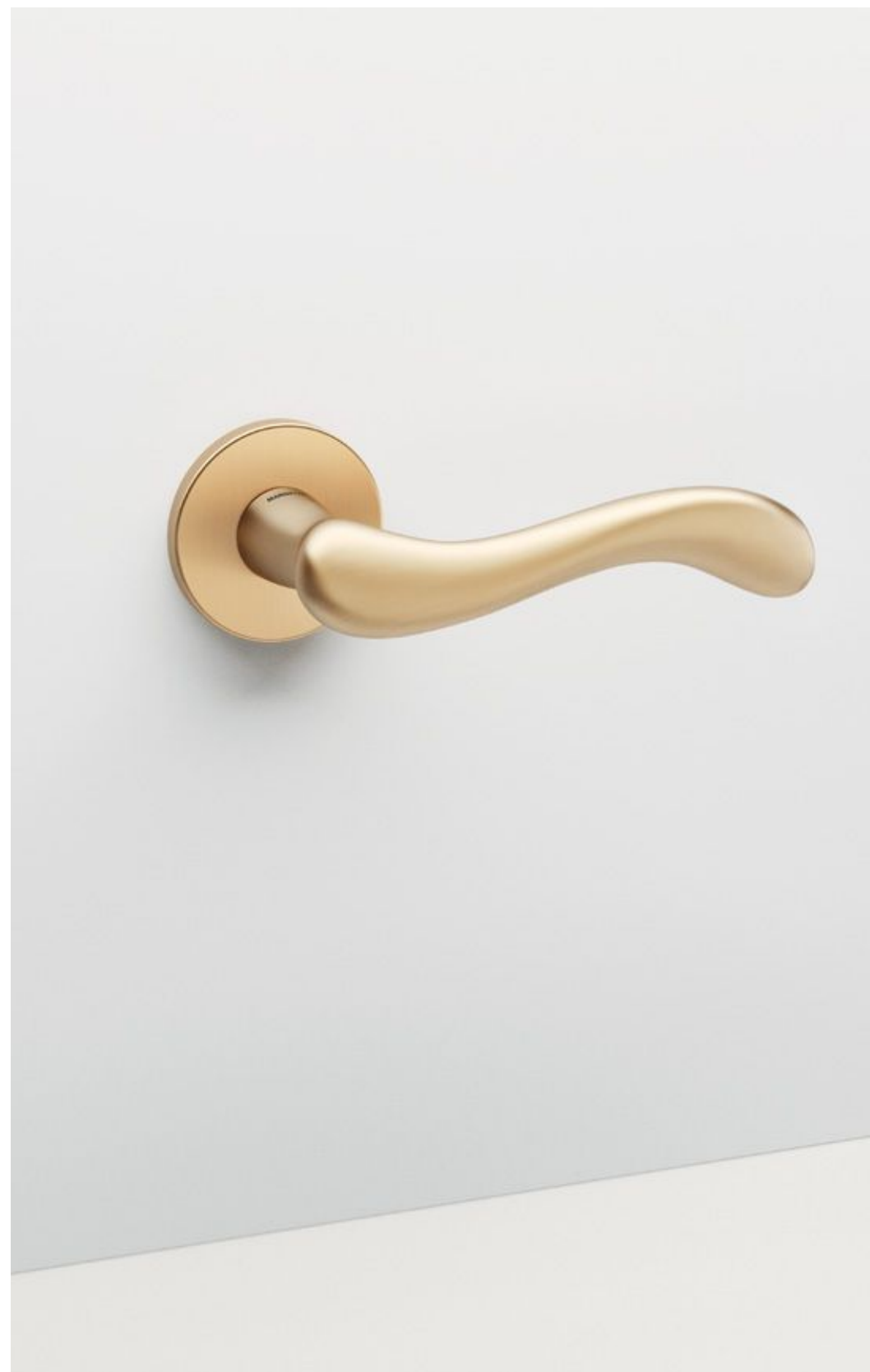

aqualung

design Franco Poli



03 Oro lucido
Polished brass



04/03 Oro satinato/lucido
Satin/ Polished brass



26 Cromo lucido
Polished chrome



26D/26 Cromo satinato/lucido
Satin/ Polished chrome



15A Grafite
Graphite



MSN Nickel satinato opaco
Matt satin nickel

collezione / collection

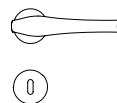

1791 con rosetta
on rose

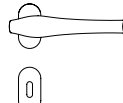

1791/BS con rosetta stretta
on tight rose



1792/DK martellina
drehkipp system

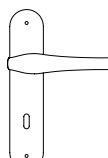

1790 con piastra
on back plate



ara



04/03 Oro satinato/lucido
Satin brass / Polished brass



26D /26 Cromo satinato/lucido
Satin chrome / Polished chrome



MSN Nickel satinato opaco
Matt satin nickel



MBR Brunito opaco
Matt bronze

collezione / collection

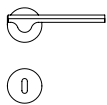

3191 con rosetta
on rose

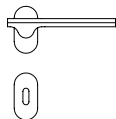

3191/BS con rosetta stretta
on tight rose



3192/DK martellina
drehkipp system

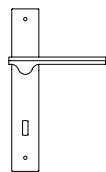

3190 con piastra
on back plate



aries

design Giuseppe Bavuso



04 Oro satinato
Satin brass



26D Cromo satinato
Satin chrome



MSN Nickel satinato opaco
Matt satin nickel



15A Grafite
Graphite



MB Nero opaco
Matt black

collezione / collection

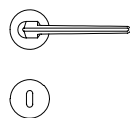

1941 con rosetta
on rose

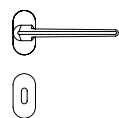

1941/BS con rosetta stretta
on tight rose



1942/DK martellina
drehkipp system

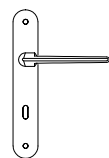

1940 con piastra
on backplates

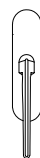

195/A alzante
lift and slide



astrid



03 Oro lucido
Polished brass



04 Oro satinato
Satin brass



26 Cromo lucido
Polished chrome



26D Cromo satinato
Satin chrome



MSN Nickel satinato opaco
Matt satin nickel



15A Grafite
Graphite

collezione / collection

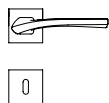

1631 con rosetta
on rose

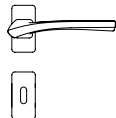

1631/BS con rosetta stretta
on tight rose

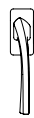

1632/DK martellina
drehkipp system

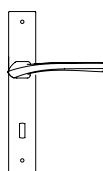

1630 con piastra
on back plate



aurora



24KT Oro
24KT gold



26 Cromo lucido
Polished chrome



04/03 Oro satinato/lucido
Satin/Polished brass



28 Argento vecchio
Antique chrome



RGS/RG Oro rosa
Rose gold



MBR Brunito opaco
Matt bronze

Disponibile nella versione pelle
Available in leather version

collezione / collection

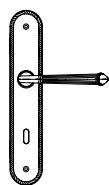

1510 con piastra
on back plate

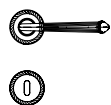

1511 con rosetta
on rose



1512/M cremonese window
lever-handle



1512/DK martellina
drehkipp system



bilbao



03 Oro lucido
Polished brass



04 Oro satinato
Satin brass



03/04 Oro lucido/satinato
Polished/Satin brass



26/26D Cromo lucido/satinato
Polished/Satin chrome



26 Cromo lucido
Polished chrome



26D Cromo satinato
Satin chrome

Disponibile nella versione Incisa e pelle
Available in Incisa and leather version

collezione / collection

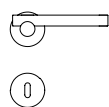

1671 con rosetta
on rose

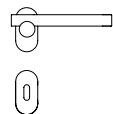

1671/BS con rosetta stretta
on tight rose



1672/DK martellina
drehkipp system

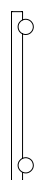

1675 | 1675S maniglione
pull handle



câlin

design Alessandro Corina



26D Cromo satinato
Satin chrome



04 Oro satinato
Satin brass



MSN Nickel satinato opaco
Matt satin nickel

collezione / collection

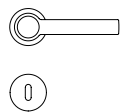

1991 con rosetta
on rose

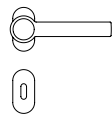

1991/BS con rosetta stretta
on tight rose



1992/DK martellina
drehkipp system



callas

design Piet Billekens



03 Oro lucido
Polished brass



04 Oro satinato
Satin brass



26 Cromo lucido
Polished chrome



26D Cromo satinato
Satin chrome



1B Bronzo scultura
Imperial bronze



BP Nero perla
Black pearl



15A Grafite
Graphite

collezione / collection

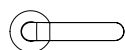

1611 con rosetta
on rose

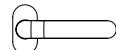

1611/BS con rosetta stretta
on tight rose



1612/DK martellina
drehkipp system

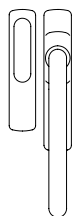

196/A alzante
lift and slide



carré

design Piet Billekens



03 Oro lucido
Polished brass



04 Oro satinato
Satin brass



26 Cromo lucido
Polished chrome



26D Cromo satinato
Satin chrome

collezione / collection



1620 con rosetta
on rose



chrono k

design Dodo Arslan



26D Cromo satinato
Satin chrome



04 Oro satinato
Satin brass



MSN Nickel satinato opaco
Matt satin nickel

collezione / collection



1984P con rosetta
on rose



1984 con rosetta
on rose



1987 fermaporta
doorstop



1989 appendiabiti
clothes hanger



chrono h

design Dodo Arslan



26D Cromo satinato
Satin chrome



04 Oro satinato
Satin brass



MSN Nickel satinato opaco
Matt satin nickel

collezione / collection

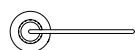

1981 con rosetta
on rose



1981/BS con rosetta stretta
on tight rose



1982/DK martellina
drehkipp system



cocò



04/03 Oro satinato/lucido
Satin/Polished brass



26 Cromo lucido
Polished chrome



PB/BR Brunito
Bronze



MBR Brunito opaco
Matt bronze

collezione / collection

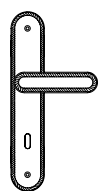

1640 con piastra
on back plate

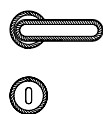

1641 con rosetta
on rose

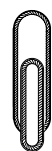

1642/M cremonese window
lever-handle



1642/DK martellina
drehkip system



coupé

design Dodo Arslan



03 Oro lucido
Polished brass



26 Cromo lucido
Polished chrome



04 Oro satinato
Satin brass



26D Cromo satinato
Satin chrome



MB Nero opaco
Matt black

collezione / collection



1971 con rosetta
on rose



1971/BS con rosetta stretta
on tight rose

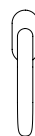

1972/DK martellina
drehkipp system



doge



24KT Oro lucido/Ceramica
24KT gold brass/Ceramic



03 Oro lucido/Ceramica
Polished brass/Ceramic



28 Argento vecchio/Ceramica
Antique chrome/Ceramic



AB Brunito antico/Ceramica
Antique bronze/Ceramic

collezione / collection

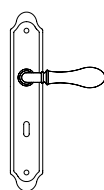

640 con piastra
on back plate

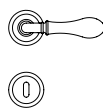

641 con rosetta
on rose

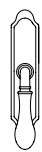

642/M cremonese window
lever-handle

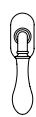

642/DK martellina
drehkip system



fan



04 Oro satinato
Satin brass



IB Bronzo scultura
Imperial bronze



26 Cromo lucido
Polished chrome



26D Cromo satinato
Satin chrome



MSN Nickel satinato opaco
Matt satin nickel

collezione / collection

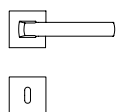

1291 con rosetta
on rose

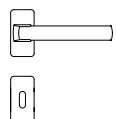

1291/BS con rosetta stretta
on tight rose

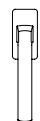

1292/DK martellina
drehkipp system

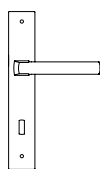

1290 con piastra
on back plate



fenix

design Piet Billekens



03 Oro lucido
Polished brass



04 Oro satinato
Satin brass



26 Cromo lucido
Polished chrome



26D Cromo satinato
Satin chrome



MSN Nickel satinato opaco
Matt satin nickel

collezione / collection

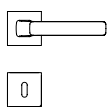

1601 con rosetta
on rose

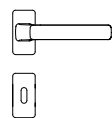

1601/BS con rosetta stretta
on tight rose



1602/DK martellina
drehkipp system



filo



04/03 Oro satinato/lucido
Satin/polished brass



MBR Brunito opaco
Matt bronze



26D/26 Cromo satinato/lucido
Satin /Polished chrome



MSN Nickel satinato opaco
Matt satin nickel

collezione / collection

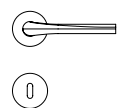

721 con rosetta
on rose

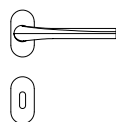

721/BS con rosetta stretta
on tight rose



722/DK martellina
drehkipp system

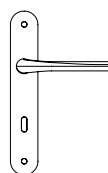

720 con piastra
on back plate



frame

design WA+CH



04/03 Oro satinato/lucido
Satin/polished brass



RGS/RG Oro rosa satinato/lucido
Satin/polished rose gold



26D/26 Cromo satinato/lucido
Satin /Polished chrome



MB Nero opaco
Matt black

collezione / collection

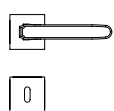

1871 con rosetta
on rose

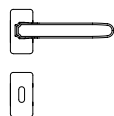

1871/BS con rosetta stretta
on tight rose



1872/DK martellina
drehkipp system



fusilla

design Alessandro Dubini



03 Oro lucido
Polished brass



MBR Brunito opaco
Matt bronze



26 Cromo lucido
Polished chrome



15A Grafite
Graphite



collezione / collection

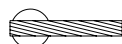

1731 con rosetta
on rose

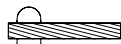

1731/BS con rosetta stretta
on tight rose



1732/DK martellina
drehkipp system



1735 | 1735S maniglione
pull handle

gou



03 Oro lucido
Polished brass



04 Oro satinato
Satin brass



28 Argento vecchio
Antique chrome



MW Bianco opaco
Matt white

collezione / collection

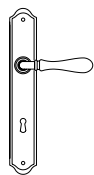

1420 con piastra
on back plate

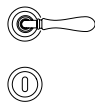

1421 con rosetta
on rose

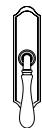

1422/M cremonese window
lever-handle



1422/DK martellina
drehkipp system

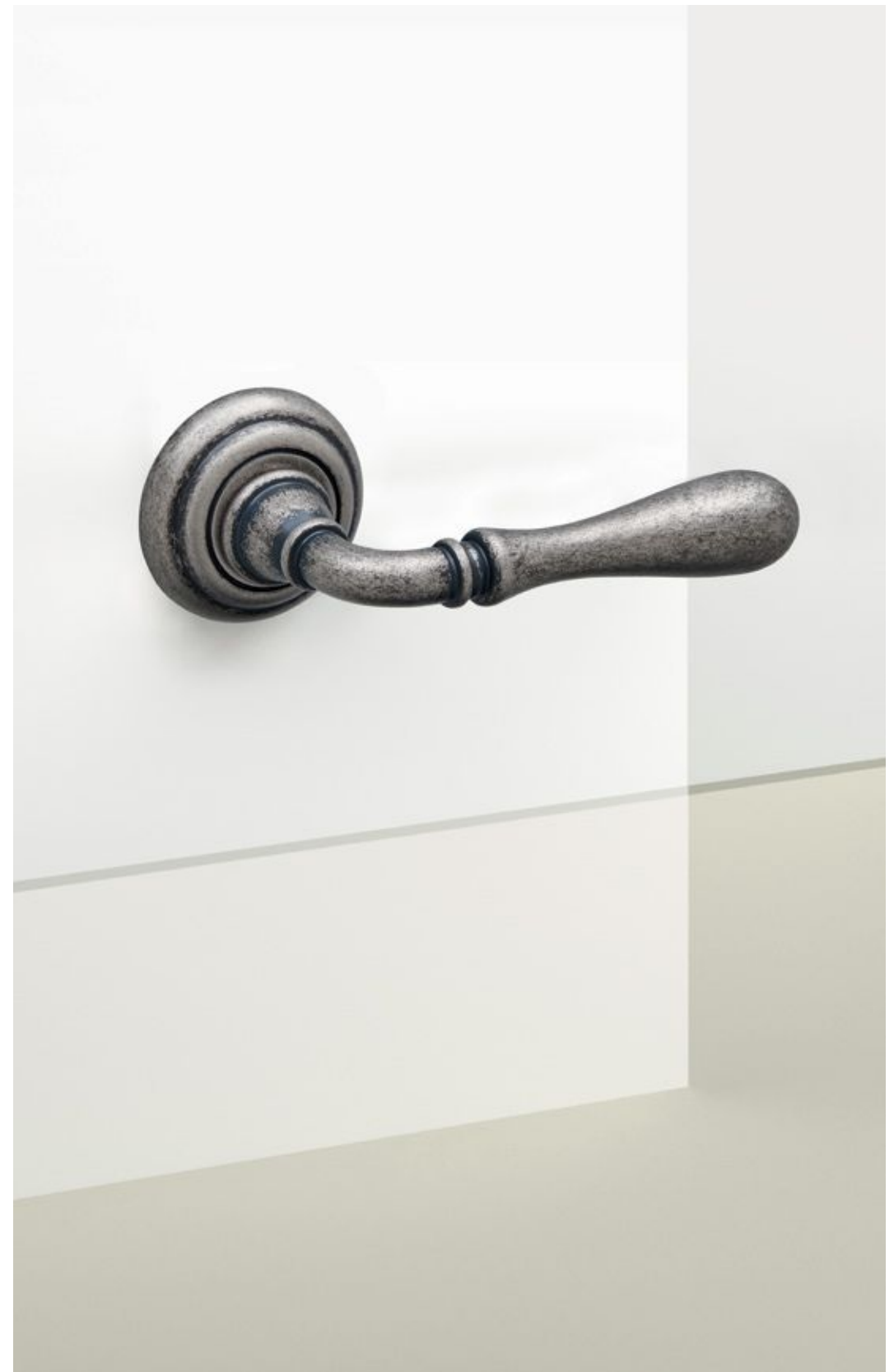

grint



04 Oro satinato
Satin brass



MBR Brunito opaco
Matt bronze



26 Cromo lucido
Polished chrome



26D Cromo satinato
Satin chrome



MSN Nickel satinato opaco
Matt satin nickel



15A Grafite
Graphite



Incisa
Engraved



K Godronata
Knurled

collezione / collection

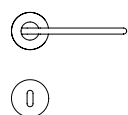

1751 con rosetta
on rose

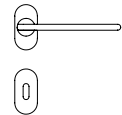

1751/BS con rosetta stretta
on tight rose



1752/DK martellina
drehkipp system



hartù



03 Oro lucido
Polished brass



04 Oro satinato
Satin brass



28 Argento vecchio
Antique chrome



MBR Brunito opaco
Matt bronze

Disponibile nella versione pelle
Available in leather version

collezione / collection

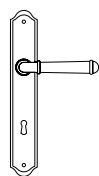

1340 con piastra
on back plate

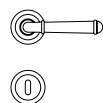

1341 con rosetta
on rose



1342/M cremonese window
lever-handle



1342/DK martellina
drehkipp system



isi



04 Oro satinato
Satin brass



MSN Nickel satinato opaco
Matt satin nickel



26 Cromo lucido
Polished chrome



26D Cromo satinato
Satin chrome



collezione / collection

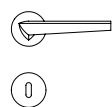

1081 con rosetta
on rose

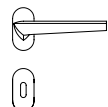

1081/BS con rosetta stretta
on tight rose



1082/DK martellina
drehkipp system

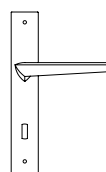

1080 con piastra
on back plate

jet



04 Oro satinato
Satin brass



MB Nero opaco
Matt black



26 Cromo lucido
Polished chrome



26D Cromo satinato
Satin chrome



collezione / collection

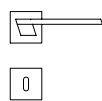

1371 con rosetta
on rose

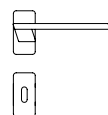

1371/BS con rosetta stretta
on tight rose



1372/DK martellina
drehkipp system

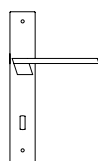

1370 con piastra
on back plate

juno

design Alessandro Dubini



Cenere
Ash



Grafite
Graphite



Sabbia
Sand



Tortora
Dove



Cipria
Blush



collezione / collection

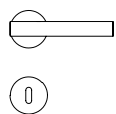

8021 con rosetta
on rose



8022/DK martellina
drehkipp system



K

design Alessandro Dubini



03 Oro lucido
Polished brass



04 Oro satinato
Satin brass



26 Cromo lucido
Polished chrome



26D Cromo satinato
Satin chrome



MB Nero opaco
Matt black



MW Bianco opaco
Matt white



collezione / collection



1950



kiri



03 Oro lucido
Polished brass



04 Oro satinato
Satin brass



26 Cromo lucido
Polished chrome



26D Cromo satinato
Satin chrome



MSN Nickel satinato opaco
Matt satin nickel



MBR Brunito opaco
Matt bronze

collezione / collection

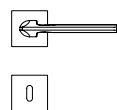

1461 con rosetta
on rose

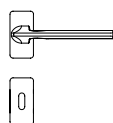

1461/BS con rosetta stretta
on tight rose



1462/DK martellina
drehkipp system

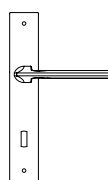

1460 con piastra
on back plate



kuki



03 Oro lucido
Polished brass



03/04 Oro lucido/satinato
Polished/Satin brass



26 Cromo lucido
Polished chrome



26/26D Cromo lucido/satinato
Polished/Satin chrome



MBR Brunito opaco
Matt bronze



15A Grafite
Graphite

Disponibile nella versione Incisa
Available in its Incisa version

collezione / collection



1741 con rosetta
on rose

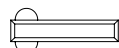

1741/BS con rosetta stretta
on tight rose



1742/DK martellina
drehkipp system

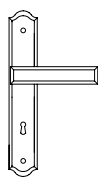

1740 con piastra
on back plate



lario



03 Oro lucido
Polished brass



MSN Nickel satinato opaco
Matt satin nickel



26 Cromo lucido
Polished chrome



26D Cromo satinato
Satin chrome



collezione / collection

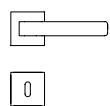

1681 con rosetta
on rose

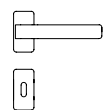

1681/BS con rosetta stretta
on tight rose



1682/DK martellina
drehkip system

led



03 Oro lucido
Polished brass



MSN Nickel satinato opaco
Matt satin nickel



26 Cromo lucido
Polished chrome



26D Cromo satinato
Satin chrome

collezione / collection

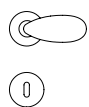

1091 con rosetta
on rose

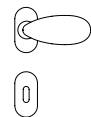

1091/BS con rosetta stretta
on tight rose

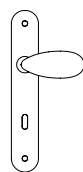

1090 con piastra
on back plate

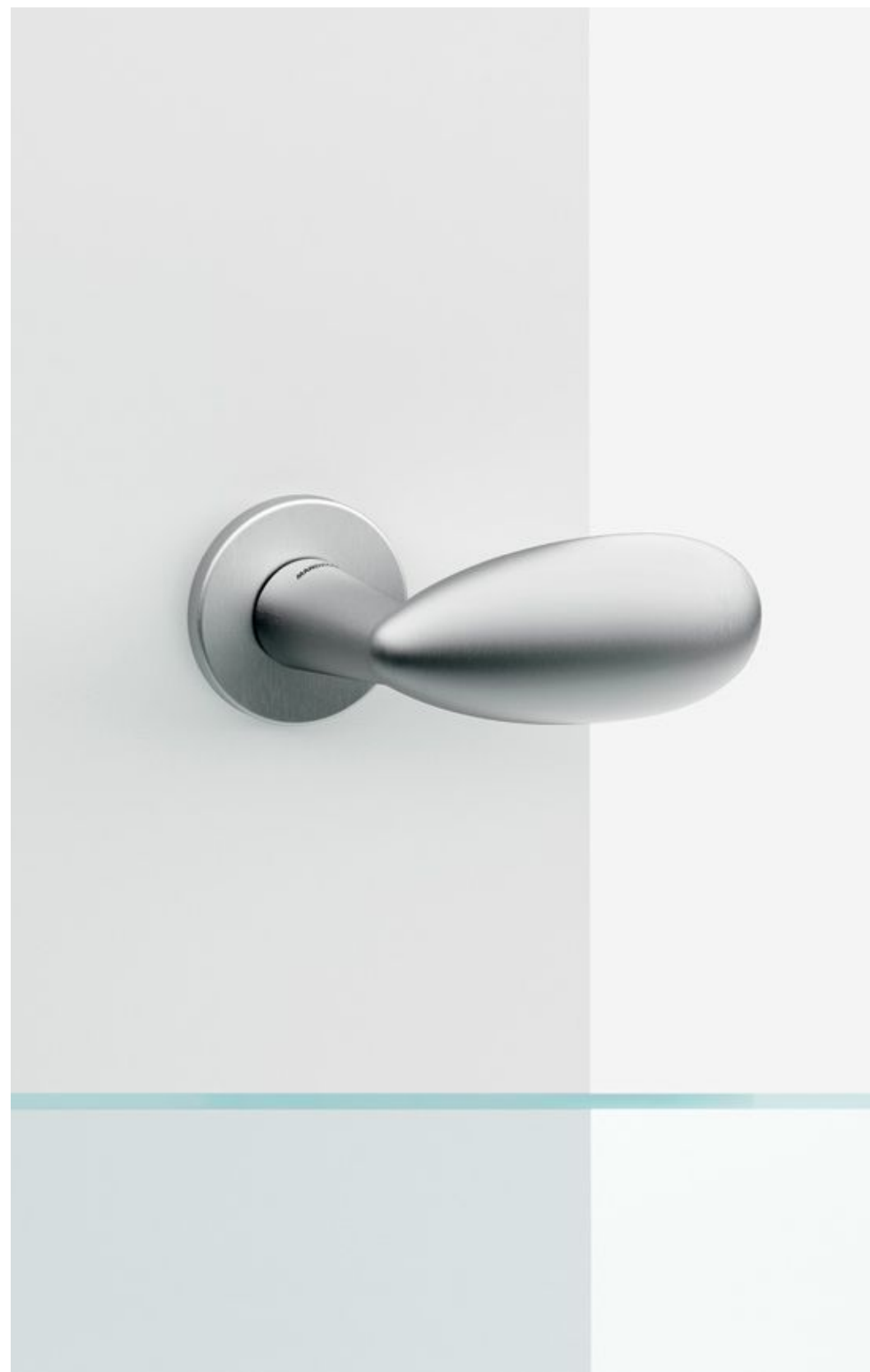

life



03/04 Oro lucido/satinato
Polished/Satin brass



26/26D Cromo lucido/satinato
Polished/Satin chrome



15A Grafite
Graphite



collezione / collection

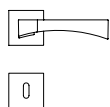

1171 con rosetta
on rose

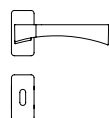

1171/BS con rosetta stretta
on tight rose

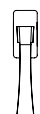

1172/DK martellina
drehkipp system

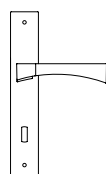

1170 con piastra
on back plate

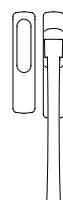

197/A alzante
lift and slide

link

design Pierfrancesco Arnone



03 Oro lucido
Polished brass



04 Oro satinato
Satin brass



26 Cromo lucido
Polished chrome



26D Cromo satinato
Satin chrome



MSN Nickel satinato opaco
Matt satin nickel



MBR Brunito opaco
Matt bronze

collezione / collection

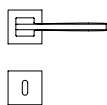

1031 con rosetta
on rose

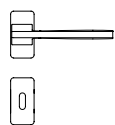

1031/BS con rosetta stretta
on tight rose



1032/DK martellina
drehkipp system

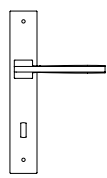

1030 con piastra
on back plate



1035 maniglione
pull handle



lord



03/04 Oro lucido/satinato
Polished/Satin brass



04/03 Oro satinato/lucido
Satin/Polished brass



PB/BR Brunito
Bronze



MBR Brunito opaco
Matt bronze



collezione / collection

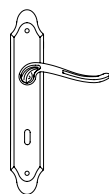

1020 con piastra
on back plate

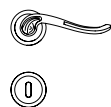

1021 con rosetta
on rose



1022/M cremonese window
lever-handle



1022/DK martellina
drehkip system

melody



03 Oro lucido/Ceramica
Polished brass/Ceramic



04 Oro satinato/Ceramica
Satin brass/Ceramic



24KT Oro/Ceramica
24KT gold/Ceramic



MBR Brunito opaco/Ceramica
Matt bronze/Ceramic



26 Cromo lucido/Ceramica
Polished chrome/Ceramic



28 Argento vecchio/Ceramica
Antique chrome/Ceramic

Disponibile nella versione Leather
Available in Leather version

collezione / collection

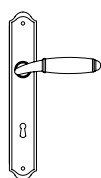

1200 con piastra
on back plate

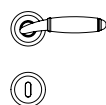

1201 con rosetta
on rose



1202/M cremonese window
lever-handle



1202/DK martellina
drehkipp system



mitos



03 Oro lucido
Polished brass



04 Oro satinato
Satin brass



26 Cromo lucido
Polished chrome



26D Cromo satinato
Satin chrome



MSN Nickel satinato opaco
Matt satin nickel

collezione / collection



1131 con rosetta
on rose

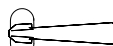

1131/BS con rosetta stretta
on tight rose



1132/DK martellina
drehkipp system

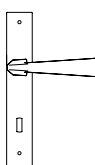

1130 con piastra
on back plate



MM80

design Marcello Morandini



MW/MB Bianco-Nero
Matt white / Matt black



MB/BI Nero-Bianco
Matt black / Matt white



MW Bianco opaco
Matt white



MB Nero opaco
Matt black



26 Cromo lucido
Polished chrome



26D Cromo satinato
Satin chrome



MSN Nickel satinato opaco
Matt satin nickel



collezione / collection

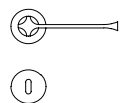

1921 con rosetta
on rose

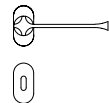

1921/BS con rosetta stretta
on tight rose



1922/DK martellina
drehkipp system



nadir



03 Oro lucido
Polished brass



04 Oro satinato
Satin brass



26 Cromo lucido
Polished chrome



26D Cromo satinato
Satin chrome



BP Nero Perla
Black Pearl

collezione / collection

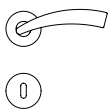

771 con rosetta
on rose

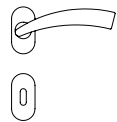

771/BS con rosetta stretta
on tight rose



772/DK martellina
drehkipp system

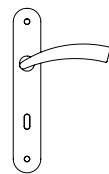

770 con piastra
on back plate



775 maniglione
pull handle



naxos



03 Oro lucido/Bianco Calacatta
Polished brass/White Calacatta



24KT Oro/Bianco Calacatta
24KT gold/White Calacatta



AB Brunito antico/Bianco Calacatta
Antique bronze/White Calacatta



MBR Brunito opaco/Nero Marquinia
Matt bronze/Black Marquinia



26 Cromo lucido/Nero Marquinia
Polished chrome/Black Marquinia

Disponibile nella versione marmo Marquinia nero / Calacatta bianco
Available in marble version black Marquinia / White Calacatta

collezione / collection

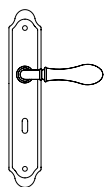

8010 con piastra
on back plate

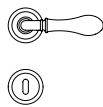

8011 con rosetta
on rose

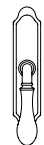

8012/M cremonese window
lever-handle



8012/DK martellina
drehkipp system

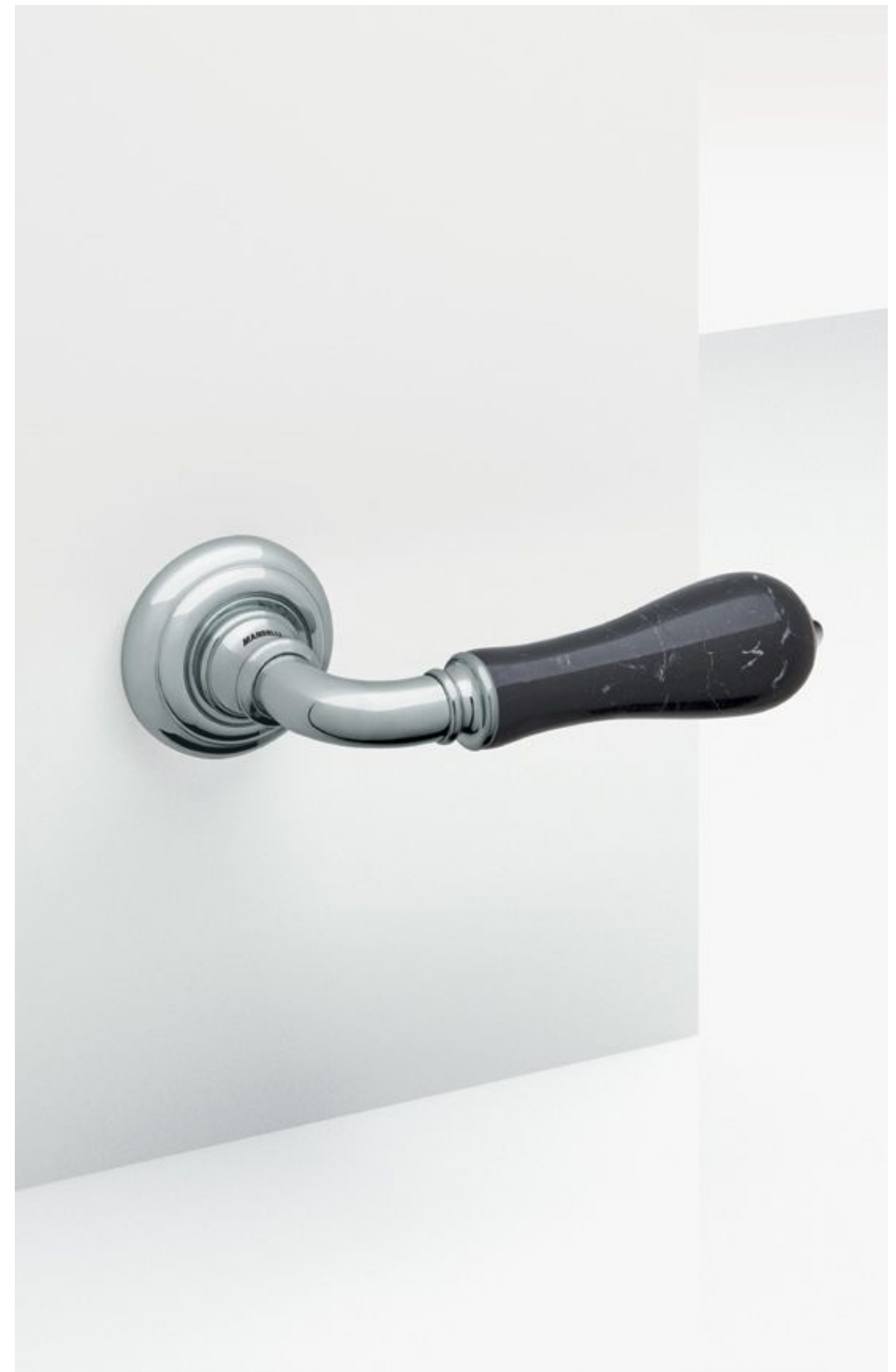

norma



03 Oro lucido
Polished brass



04 Oro satinato
Satin brass



PB/BR Brunito lucido
Polished bronze



MBR Brunito opaco
Matt bronze



26 Cromo lucido
Polished chrome

collezione / collection

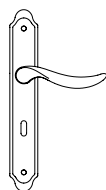

1210 con piastra
on back plate

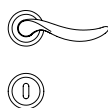

1211 con rosetta
on rose



1212/M cremonese window
lever-handle



1212/DK martellina
drehkip system



nuria



04 Oro satinato
Satin brass



15A Grafite
Graphite



26D Cromo satinato
Satin chrome



MSN Nickel satinato opaco
Matt satin nickel



collezione / collection

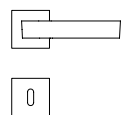

1501 con rosetta
on rose

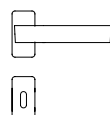

1501/BS con rosetta stretta
on tight rose



1502/DK martellina
drehkipp system

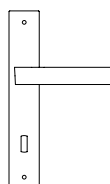

1500 con piastra
on back plate

ola



03 Oro lucido
Polished brass



04 Oro satinato
Satin brass



26 Cromo lucido
Polished chrome



26D Cromo satinato
Satin chrome



MSN Nickel satinato opaco
Matt satin nickel

Disponibile nella versione Incisa
Available in Incisa version

collezione / collection

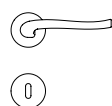

1071 con rosetta
on rose

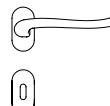

1071/BS con rosetta stretta
on tight rose



1072/DK martellina
drehkipp system

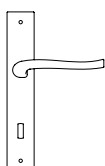

1070 con piastra
on back plate



paros



03 Oro lucido/Nero Marquinia
Polished brass/Black Marquinia



04 Oro satinato/Bianco Calacatta
Satin brass/White Calacatta



24KT Oro/Nero Marquinia
24KT gold/Black Marquina



MBR Brunito opaco/Bianco Calacatta
Matt bronze/White Calacatta



26 Cromo lucido/Nero Marquinia
Polished chrome/Black Marquina

Disponibile nella versione marmo Marquinia nero / Calacatta bianco
Available in marble version black Marquinia / White Calacatta

collezione / collection

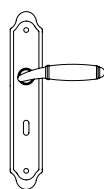

8000 con piastra
on back plate

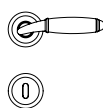

8001 con rosetta
on rose



8002/M cremonese window
lever-handle



8002/DK martellina
drehkipp system

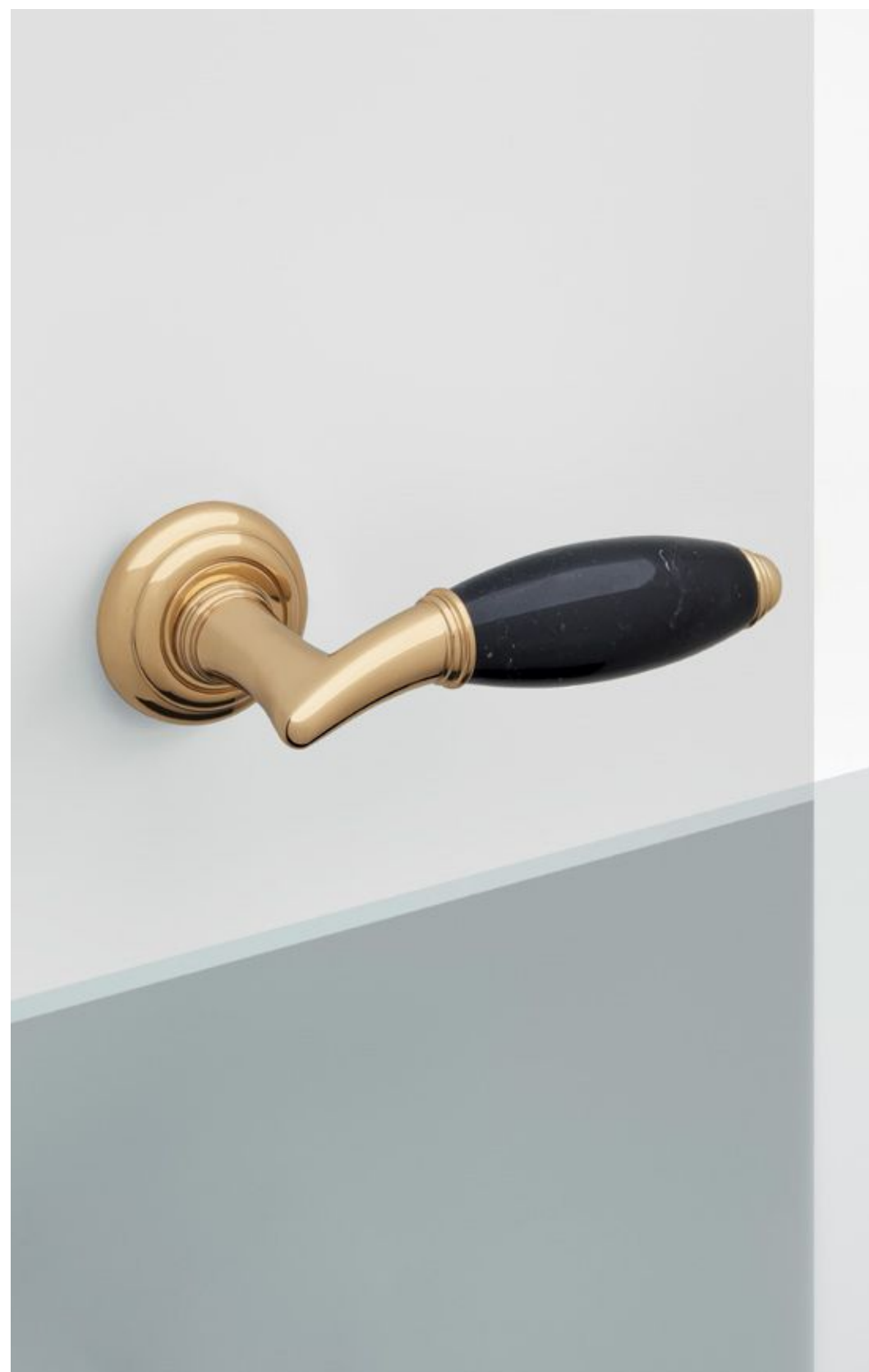

piramid



26D Cromo satinato
Satin chrome



15A Grafite
Graphite



MSN Nickel satinato opaco
Matt satin nickel



collezione / collection

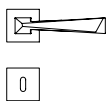

1251 con rosetta
on rose

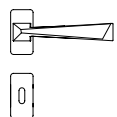

1251/BS con rosetta stretta
on tight rose



1252/DK martellina
drehkipp system

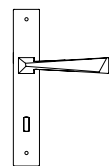

1250 con piastra
on back plat



1255 maniglione
pull handle

plissé



03 Oro lucido
Polished brass



03/04 Oro lucido/satinato
Polished/Satin brass



PB/BR Brunito
Bronze



MBR Brunito opaco
Matt bronze



26 Cromo lucido
Polished chrome

collezione / collection

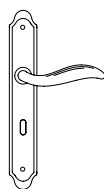

980 con piastra
on back plate

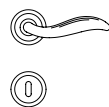

981 con rosetta
on rose



982/M cremonese window
lever-handle



982/DK martellina
drehkipp system

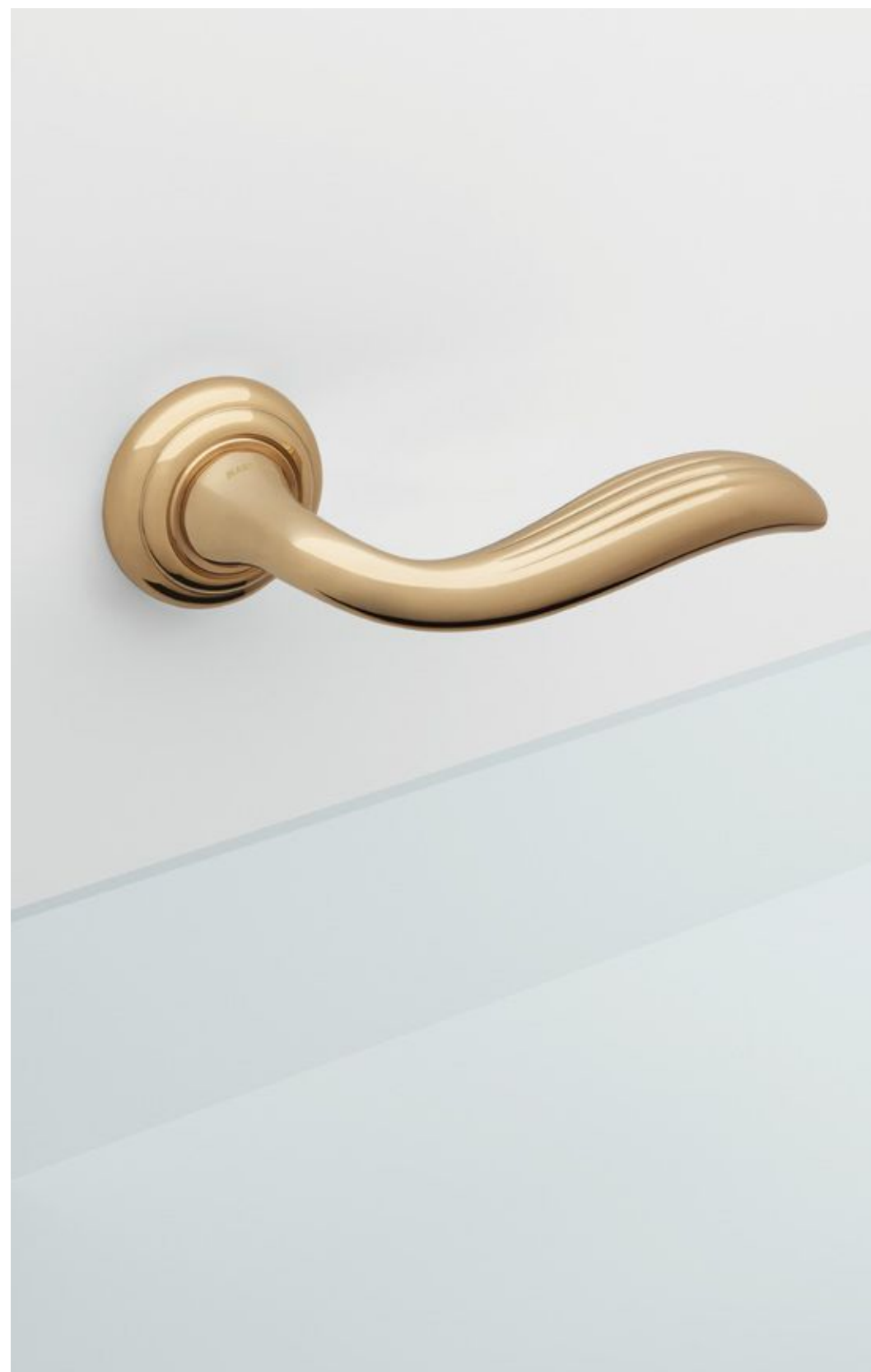

PP33

design Piero Portaluppi



03 Oro lucido
Polished brass



RG Oro rosa lucido
Polished rose gold



26 Cromo lucido
Polished chrome



NL Nickel lucido
Polished nickel



IB Bronzo scultura
Imperial bronze



MB Nero opaco
Matt black

collezione / collection

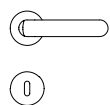

1801 con rosetta
on rose

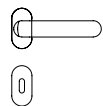

1801/BS con rosetta stretta
on tight rose



1802/DK martellina
drehkipp system

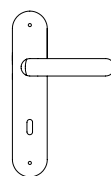

1800 con piastra
on back plate

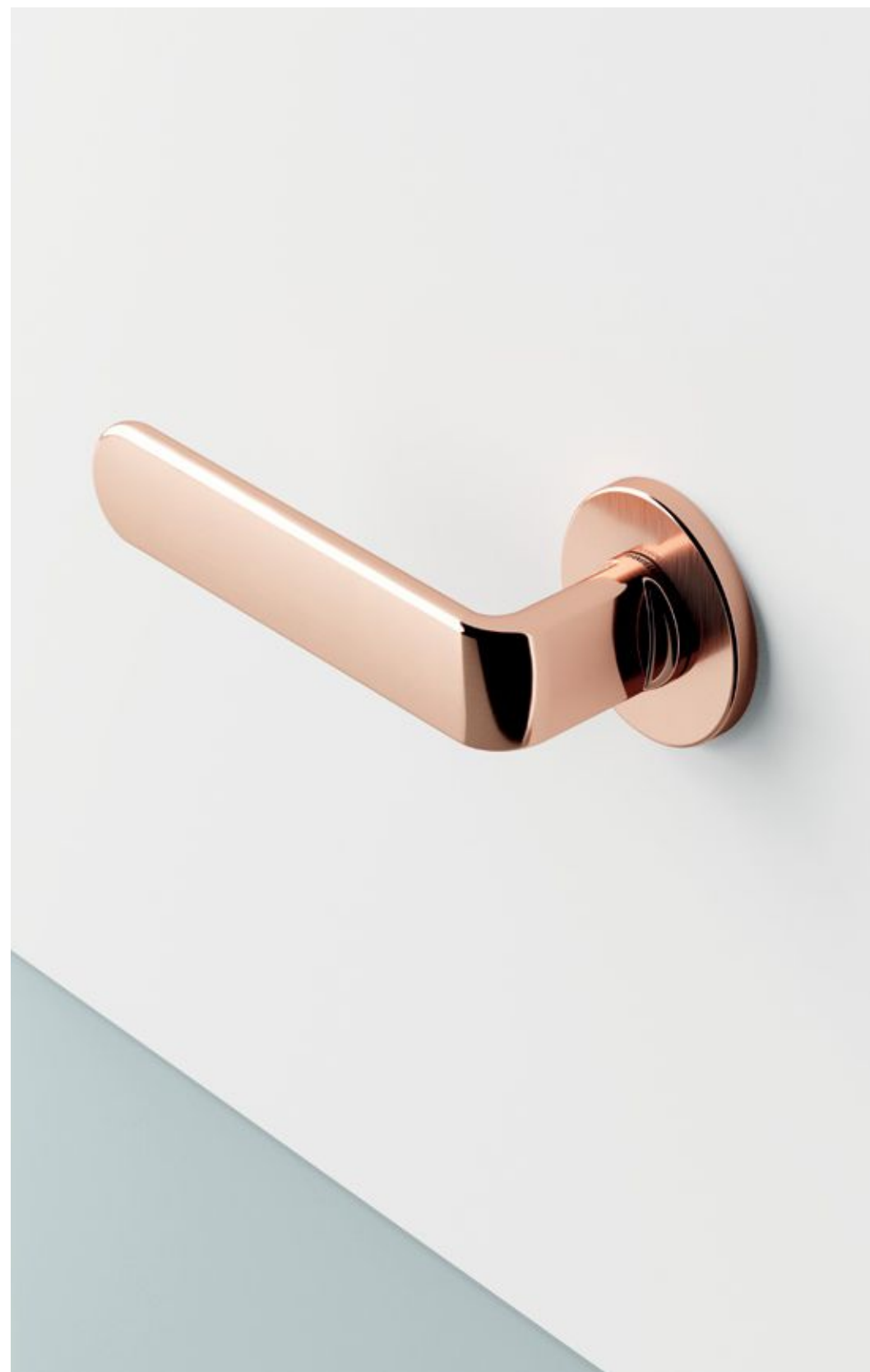

river



03 Oro lucido
Polished brass



04 Oro satinato
Satin brass



PB/BR Brunito
Bronze



MBR Brunito opaco
Matt bronze



26D Cromo satinato
Satin chrome



collezione / collection

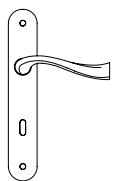

1200 con piastra
on back plat

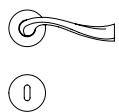

1211 con rosetta
on rose

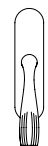

1202/M cremonese
window lever-handle



1202/DK martellina
drehkipp system



995 maniglione
pull handle

rondò



03 Oro lucido
Polished brass



04 Oro satinato
Satin brass



PB/BR Brunito
Bronze



AB Brunito antico
Antique bronze



26 Cromo lucido
Polished chrome



26D Cromo satinato
Satin chrome

collezione / collection

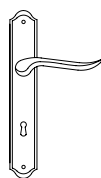

690 con piastra
on back plate

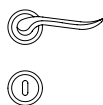

691 con rosetta
on rose



692/M cremonese window
lever-handle



692/DK martellina
drehkipp system



seven

design Marco Piva



03/04 Oro lucido/satinato
Polished/Satin brass



26/26D Cromo lucido/satinato
Polished/Satin chrome



MBR Brunito opaco
Matt bronze



1.5A Grafite
Graphite



BP Nero Perla
Black Pearl

collezione / collection

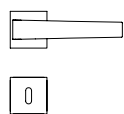

1761 con rosetta
on rose

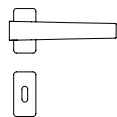

1761/BS con rosetta stretta
on tight rose



1762/DK martellina
drehkipp system



sevilla



04 Oro satinato
Satin brass



28 Argento vecchio
Antique chrome



PB/BR Brunito lucido
Polished bronze



AB Brunito antico
Antique bronze



MBR Brunito opaco
Matt bronze



IB Bronzo scultura
Imperial bronze

collezione / collection

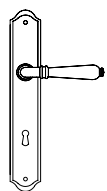

530 con piastra
on back plate

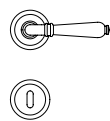

531 con rosetta
on rose

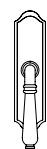

532/M cremonese window
lever-handle



532/DK martellina
drehkipp system

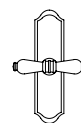

532 centrale
central lever

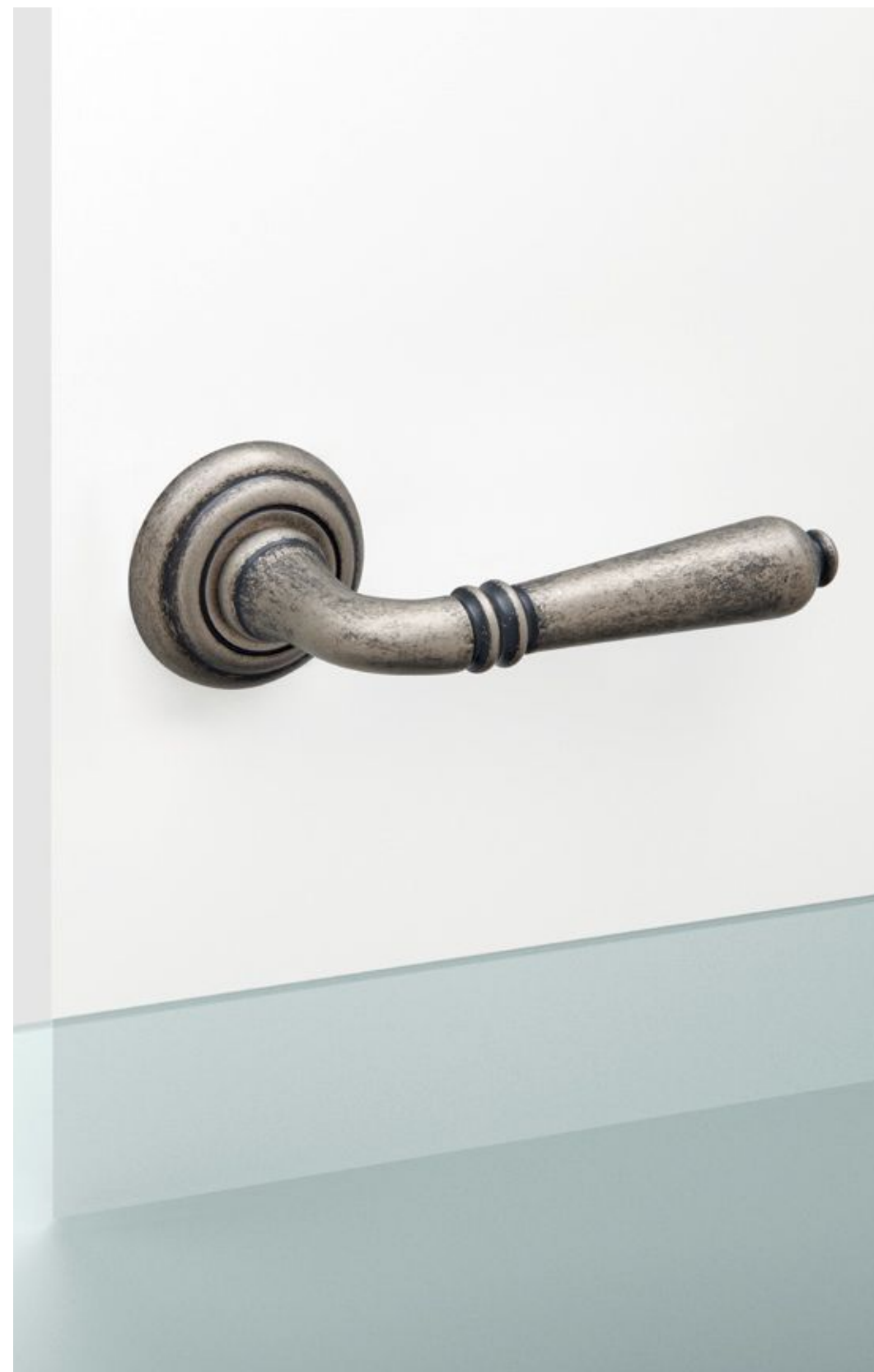

special



03/04 Oro lucido/satinato
Polished/Satin brass



26/26D Cromo lucido/satinato
Polished/Satin chrome



MBR Brunito opaco
Matt bronze

collezione / collection

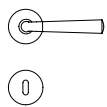

S91 con rosetta
on rose

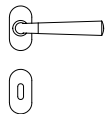

S91/BS con rosetta stretta
on tight rose



S92/DK martellina
drehkipp system

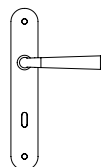

S90 con piastra
on back plate



spin



04 Oro satinato
Satin brass



MSN Nickel satinato opaco
Matt satin nickel



26 Cromo lucido
Polished chrome



26D Cromo satinato
Satin chrome



MBR Brunito opaco
Matt bronze



IB Bronzo scultura
Imperial bronze

collezione / collection

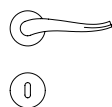

731 con rosetta
on rose

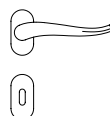

731/BS con rosetta stretta
on tight rose



732/DK martellina
drehkipp system

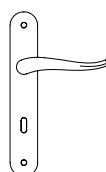

730 con piastra
on back plate



start



03/04 Oro lucido/satinato
Polished/Satin brass



26/26D Cromo lucido/satinato
Polished/Satin chrome



MBR Brunito opaco
Matt bronze

collezione / collection

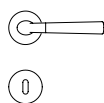

S101 con rosetta
on rose

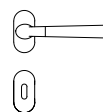

S101/BS con rosetta stretta
on tight rose



S102/DK martellina
drehkip system

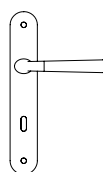

S100 con piastra
on back plate



telis



03 Oro lucido
Polished brass



04 Oro satinato
Satin brass



26 Cromo lucido
Polished chrome



26D Cromo satinato
Satin chrome



MSN Nickel satinato opaco
Matt satin nickel

Disponibile nella versione pelle
Available in leather version

collezione / collection

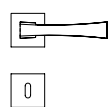

1161 con rosetta
on rose

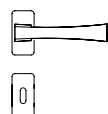

1161/BS con rosetta stretta
on tight rose



1162/DK martellina
drehkipp system

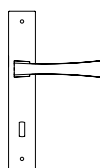

1160 con piastra
on back plate



totem



03/04 Oro lucido/satinato
Polished/Satin brass



26/26D Cromo lucido/satinato
Polished/Satin chrome



collezione / collection

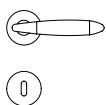

461 con rosetta
on rose

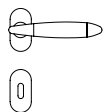

461/BS con rosetta stretta
on tight rose



462/DK martellina
drehkipp system

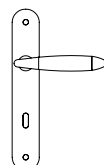

460 con piastra
on back plat



465 maniglione
pull handle

tuc



03/04 Oro lucido/satinato
Polished/Satin brass



26/26D Cromo lucido/satinato
Polished/Satin chrome

Disponibile nella versione leather
Available in leather version

collezione / collection

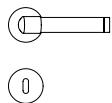

361 con rosetta
on rose

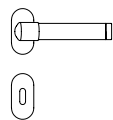

361/BS con rosetta stretta
on tight rose



362/DK martellina
drehkipp system

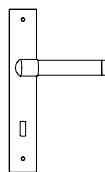

360 con piastra
on back plate



twee

design Massimo Cavana



03 Oro lucido
Polished brass



04 Oro satinato
Satin brass



26 Cromo lucido
Polished chrome



26D Cromo satinato
Satin chrome



MSN Nickel satinato opaco
Matt satin nickel



15A Grafite
Graphite

collezione / collection

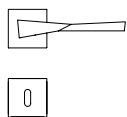

1691 con rosetta
on rose

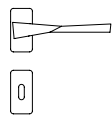

1691/BS con rosetta stretta
on tight rose



1692/DK martellina
drehkipp system



virgo

design Giuseppe Bavuso



04 Oro satinato
Satin brass



26D Cromo satinato
Satin chrome



15A Grafite
Graphite



MSN Nickel satinato opaco
Matt satin nickel



MB Nero opaco
Matt black

collezione / collection

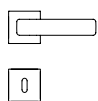

1651 con rosetta
on rose



1652/DK martellina
drehkipp system



zante



04 Oro satinato
Satin brass



26D Cromo satinato
Satin chrome



MSN Nickel satinato opaco
Matt satin nickel

collezione / collection

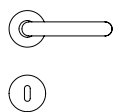

1301 con rosetta
on rose

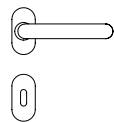

1301/BS con rosetta stretta
on tight rose



1302/DK martellina
drehkipp system

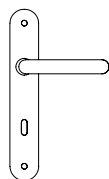

1300 con piastra
on back plat



1305 maniglione
pull handle



zeit

design Marco Piva



03 Oro lucido
Polished brass



04 Oro satinato
Satin brass



26 Cromo lucido
Polished chrome



26D Cromo satinato
Satin chrome

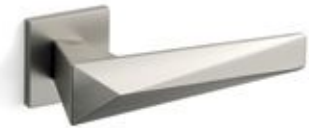

MSN Nickel satinato opaco
Matt satin nickel



MBR Brunito opaco
Matt bronze

GOOD
DESIGN
AWARD
2017

collezione / collection

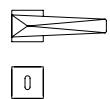

1721 con rosetta
on rose

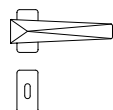

1721/BS con rosetta stretta
on tight rose



1722/DK martellina
drehkipp system



1725 maniglione
pull handle



zen



04/03 Oro satinato/lucido
Satin/Polished brass



26D/26 Cromo satinato/lucido
Satin/Polished chrome



MSN Nickel satinato opaco
Matt satin nickel



MBR Brunito opaco
Matt bronze

collezione / collection

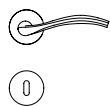

711 con rosetta
on rose

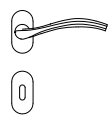

711/BS con rosetta stretta
on tight rose



712/DK martellina
drehkipp system

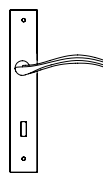

710 con piastra
on back plate



zoe



03 Oro lucido
Polished brass



04 Oro satinato
Satin brass



26 Cromo lucido
Polished chrome



26D Cromo satinato
Satin chrome



15A Grafite
Graphite

collezione / collection

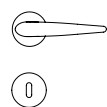

381 con rosetta
on rose

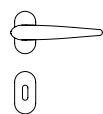

381/BS con rosetta stretta
on tight rose



382/DK martellina
drehkipp system

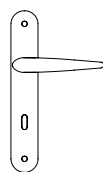

380 con piastra
on back plate



zoom



03 Oro lucido
Polished brass



04 Oro satinato
Satin brass



26 Cromo lucido
Polished chrome



26D Cromo satinato
Satin chrome



MBR Brunito opaco
Matt bronze

collezione / collection

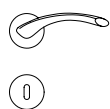

351 con rosetta
on rose

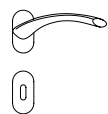

351/BS con rosetta stretta
on tight rose



352/DK martellina
drehkipp system

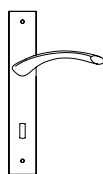

350 con piastra
on back plate



complementi e accessori
complements and accessories

Una collezione dedicata a tutti quei complementi e quegli accessori indispensabili per perfezionare un progetto, in ogni dettaglio. Interamente realizzati in ottone, made in Italy, per una proposta completa e curata.

A collection dedicated to all decorative features and essential accessories that complete a design to the finest detail. Our brass items are made entirely in Italy and offer a complete and attentively prepared range.

complementi / complements

pull handles 188
maniglioni

pull-up handles 198
maniglioni alzanti

flush handles 200
maniglie per scorrevoli

thumb turns 206
nottolini

knobs 207
pomoli

bilbao



1675

250 - 1000 mm
Ø 25 mm

1675 S

200 - 700 mm
Ø 16 mm

chicane

design Dodo Arslan



1965 SA/DA

1233 mm



1965 DX&SX

666 mm



1965 SB/DB

1233 mm



fusilla



1735

400 - 1000 mm
Ø 35 mm

1735 S

200 - 700 mm
Ø 20 mm

link



1035

250 mm

nadir



775

250 mm

nelson



1785

400 - 1000 mm
 Ø 34 mm

piramid



1255

250 mm

plissé



1125

250 mm

river



995

250 mm

rondò



3025

210 mm

sevilla



160

204 mm

totem



465 / 465 L

250 mm

zante



1305

250 mm



1315

250 mm

zeit

design Marco Piva



1725

400 mm

aries

design Giuseppe Bavuso



195/A

basic M|L



196/A

callas



198/A

life



197/A



1108 T



1108 TN/S



1108 TNN/S



1108 TC/S



1118 T



1118 TN



1118 TNN



1038



1038 TL



1038 TLN



1038 TC/S



1038 TN/S



1038



1038 C/S



368



368 TL



368 TLN



368 TC/S



368 TN/S



378



378 C/S



1028 TL



1028 TL



1028 TLN



1018



1018 TL



1018 TLN



1028 TC/S



1028 TN/S



1018 TC/S



1018 TN/S



1028



1028 C/S

nottolini / thumb turns



911-114 / RFV



1291-115 / RFV



6061



911-114 / RFV-RW



1291-115 / RFV-RW



6071



651-113 / RFV



1351-113 / RFV

pomoli / knobs



1024 / A



1024 / B



1024 / GIR



1104



644



744



854



854 / GIR



284

accessori / accessories

back plates 210
piastre

security plates 211
piastre di sicurezza

escutcheons 212
bocchette

special equipment 213
dotazioni speciali

doorstops 214
fermaporte

clothes hook 214
appendiabiti



Z



3040



S40



440



1020



1350



P55



3040-SIC



P48



690-SIC

contemporary standard



911



1291

classic standard



651



1351



911-DB

minimal



6071 / B



6071 / BY



6061 / B



6061 / BY

tight



221



221 BS



221 BS/Y



231



231 BS



231 BS/Y

US standard



1710UP



1710UP



690UP



911US



6031US



911US privacy



6031US privacy

AU standard



6011

fermaporte / doorstops



110-55

110-68



109



Caveau



Chrono
design Dodo Arslan

appendiabiti / clothes hook



Chrono
design Dodo Arslan

info tecniche / technical data



Minimal a profilo tondo
Round minimal profile



Minimal a profilo quadrato
Square minimal profile



Copertura protettiva pvd
Protective PVD coating



Disponibili in più finiture
Available in different finishes



Kit rosetta da bagno con farfalla
Thumb turn | coin release on rose
R3 113 / R4 114 / R5 115



Kit piastra da bagno con farfalla
Thumb turn | coin release on black plate
R3 113 / R4 114 / R5 115



Rosetta e bocchetta strette 31X62 mm
per infissi con montante minimale
Narrow rose and eschuteon 31x62 mm
for minimal fittings
SM senza molla | unsprung
CM con molla | with release spring



Piastra stretta 30X138 mm
per infissi con montante minimale senza
molla di ritorno
Narrow plate 30x138 mm
for unsprung fittings



DK di sicurezza
Security DK

40+1



1831
maniglia per porta con rosetta
door handle on rose

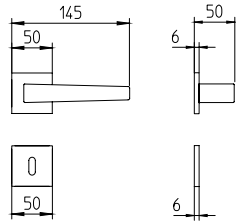

1832/DK
martellina dk
drehkipp system

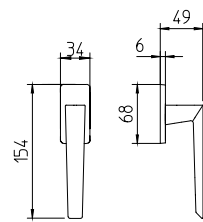

1831/R5
maniglia per porta con noddolino
door handle with thumb turn

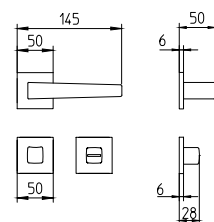

ande



451
maniglia per porta con rosetta
door handle on rose

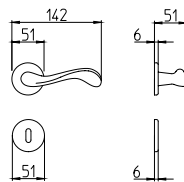

450
con piastra
on backplate

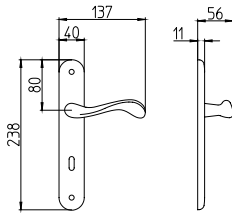

452/M
cremonese
window lever handle

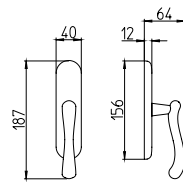

452/DK
martellina dk
drehkipp system

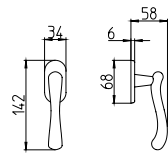

aqualung



1791
maniglia per porta con rosetta
door handle on rose

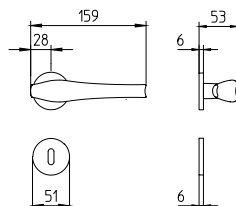

1790
con piastra
on backplate

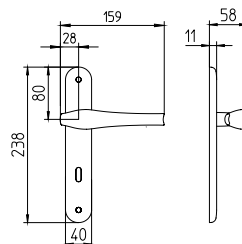

1792/M
cremonese
window lever handle

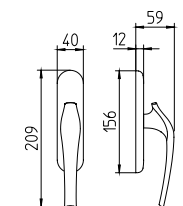

1792/DK
martellina dk
drehkipp system

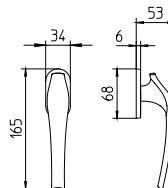

ara



3191
maniglia per porta con rosetta
door handle on rose

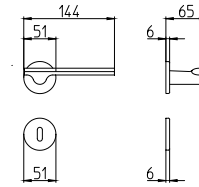

3190
con piastra
on backplate

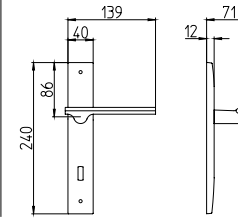

3192/M
cremonese
window lever handle

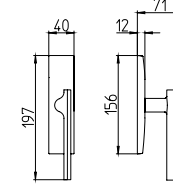

3192/DK
martellina dk
drehkipp system

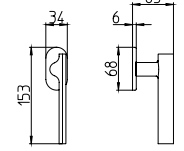

aries



1941
maniglia per porta con rosetta
door handle on rose

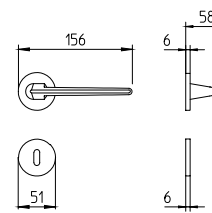

1940
con piastra
on backplate

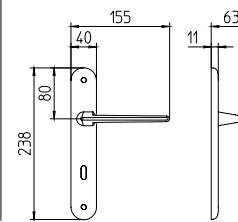

1942/M
cremonese
window lever handle

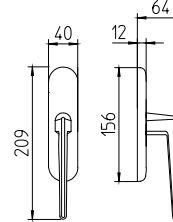

1942/DK
martellina dk
drehkipp system

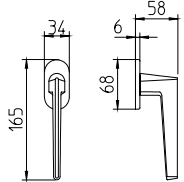

astrid



1631
maniglia per porta con rosetta
door handle on rose

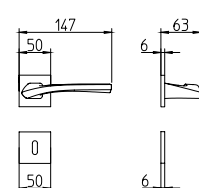

1630
con piastra
on backplate

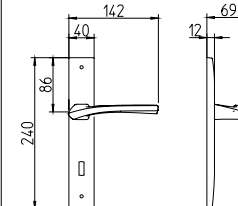

1632/M
cremonese
window lever handle

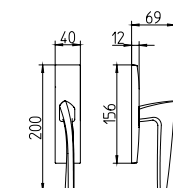

1632/DK
martellina dk
drehkipp system

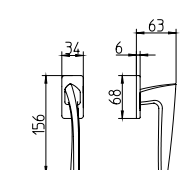

aurora



1511
maniglia per porta con rosetta
door handle on rose

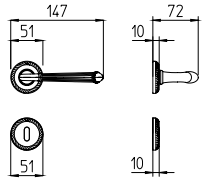

1510
con piastra
on backplate

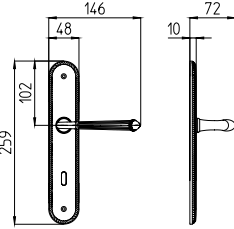

1512/M
cremonese
window lever handle

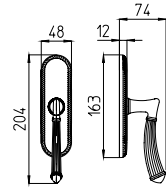

1512/DK
martellina dk
drehkipp system

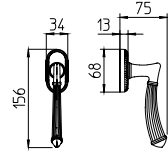

bilbao



1671
maniglia per porta con rosetta
door handle on rose

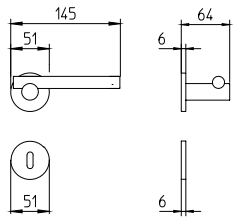

1672/M
cremonese
window lever handle

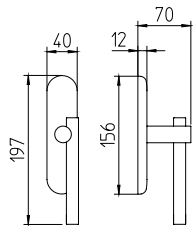

1672/DK
martellina dk
drehkipp system

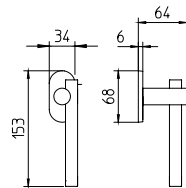

câlin



1991
maniglia per porta con rosetta
door handle on rose

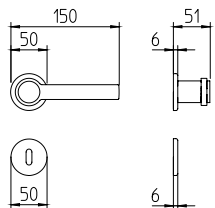

1992/DK
martellina dk
drehkipp system

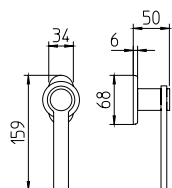

callas



1611
maniglia per porta con rosetta
door handle on rose

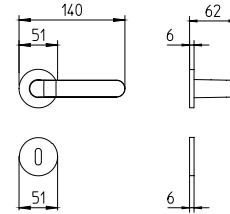

1612/M
cremonese
window lever handle

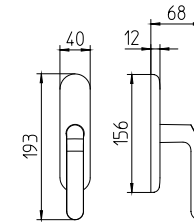

1612/DK
martellina dk
drehkipp system

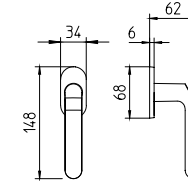

carré



1621
maniglia per porta con rosetta
door handle on rose

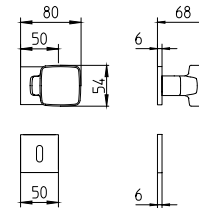

chrono k



1984
maniglia per porta con rosetta
door handle on rose

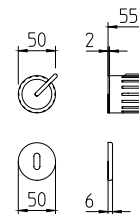

chrono h



1981
maniglia per porta con rosetta
door handle on rose

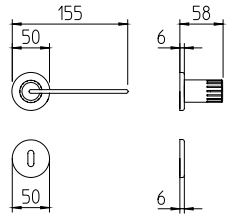

1982/DK
martellina dk
drehkipp system

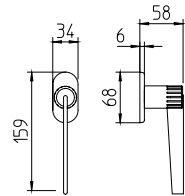

cocò



1641
maniglia per porta con rosetta
door handle on rose

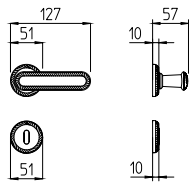

1640
con piastra
on backplate

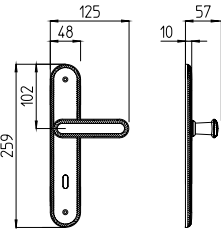

1642/M
cremonese
window lever handle

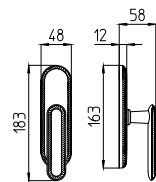

1642/DK
martellina dk
drehkipp system

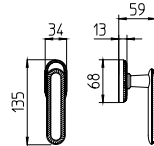

coupé



1971
maniglia per porta con rosetta
door handle on rose

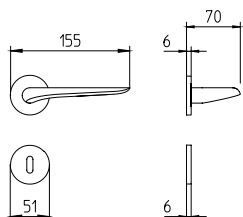

1972/DK
martellina dk
drehkipp system

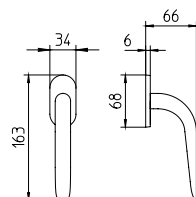

doge



641
maniglia per porta con rosetta
door handle on rose

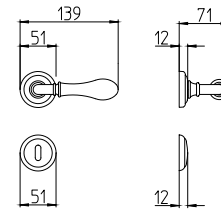

640
con piastra
on backplate

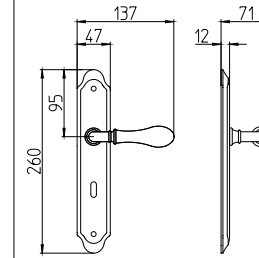

642/M
cremonese
window lever handle

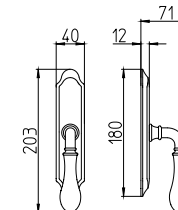

642/DK
martellina dk
drehkipp system

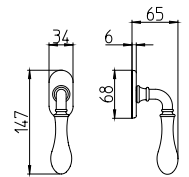

fan



1291
maniglia per porta con rosetta
door handle on rose

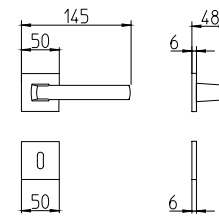

1290
con piastra
on backplate

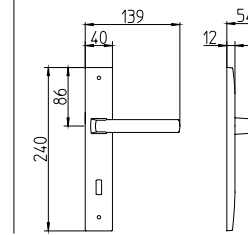

1292/M
cremonese
window lever handle

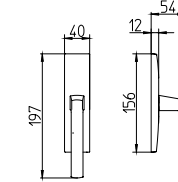

1292/DK
martellina dk
drehkipp system

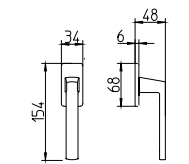

fenix



1601
maniglia per porta con rosetta
door handle on rose

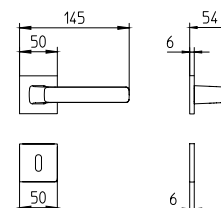

1602/M
cremonese
window lever handle

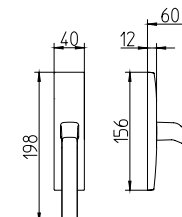

1602/DK
martellina dk
drehkipp system

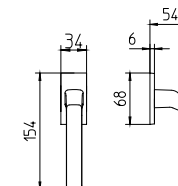

filo



721
maniglia per porta con rosetta
door handle on rose

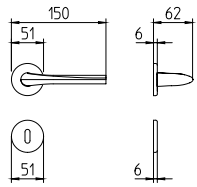

720
con piastra
on backplate

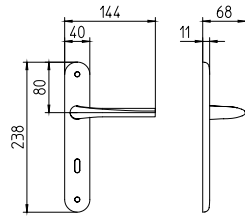

722/M
cremonese
window lever handle

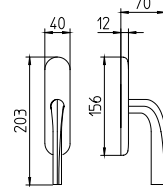

722/DK
martellina dk
drehkipp system

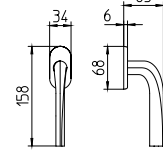

frame



1881-1881Q
maniglia per porta con rosetta
door handle on rose

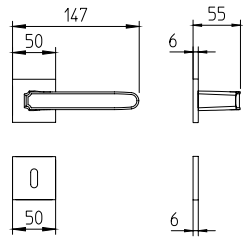

1882-1882Q/DK
martellina dk
drehkipp system

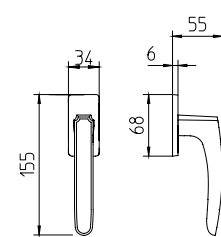

1871
maniglia per porta con rosetta
door handle on rose

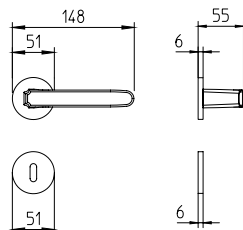

1870
con piastra
on backplate

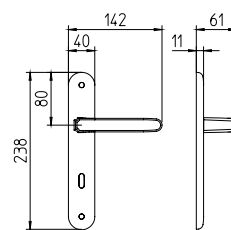

1872/M
cremonese
window lever handle

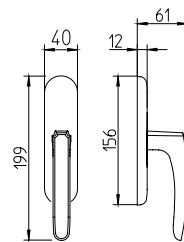

1872/DK
martellina dk
drehkipp system

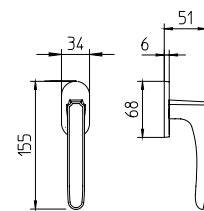

fusilla



1731
maniglia per porta con rosetta
door handle on rose

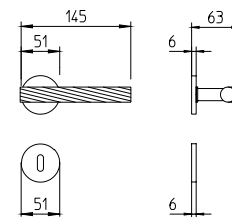

1732/M
cremonese
window lever handle

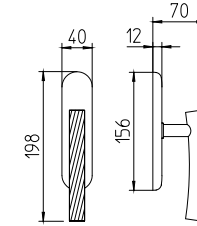

1732/DK
martellina dk
drehkipp system

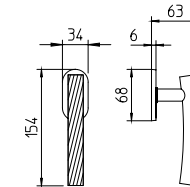

gou



1421
maniglia per porta con rosetta
door handle on rose

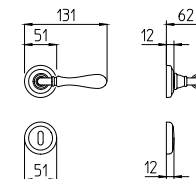

1420
con piastra
on backplate

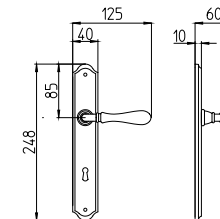

1422/M
cremonese
window lever handle

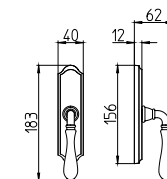

1422/DK
martellina dk
drehkipp system

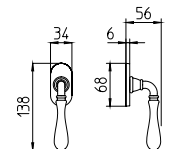

grint



1751
maniglia per porta con rosetta
door handle on rose

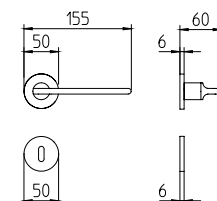

1752/M
cremonese
window lever handle

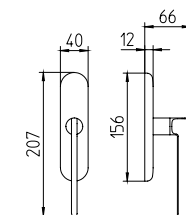

1752/DK
martellina dk
drehkipp system

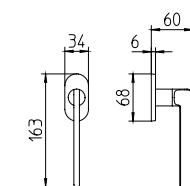



1341
maniglia per porta con rosetta
door handle on rose

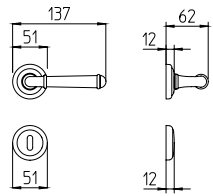

1340
con piastra
on backplate

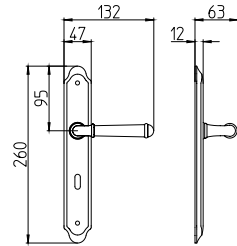

1342/M
cremonese
window lever handle

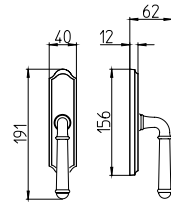

1342/DK
martellina dk
drehkipp system

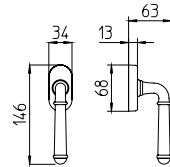

8021/M
maniglia per porta senza rosetta
door handle without rose

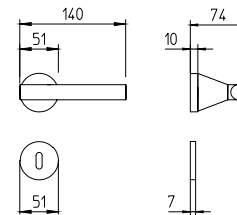

8022/DK
martellina dk
drehkipp system

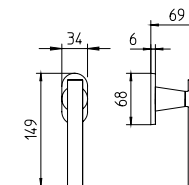

1081
maniglia per porta con rosetta
door handle on rose

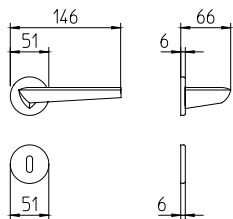

1080
con piastra
on backplate

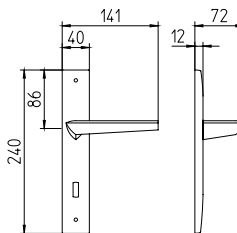

1082/M
cremonese
window lever handle

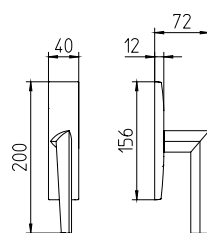

1082/DK
martellina dk
drehkipp system

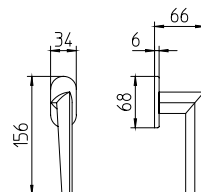

1950
maniglia
door handle

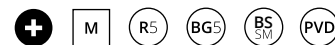
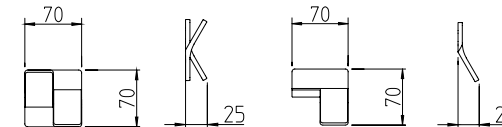

1371
maniglia per porta con rosetta
door handle on rose

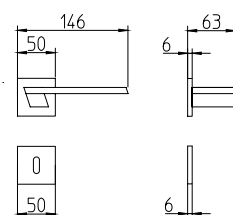

1370
con piastra
on backplate

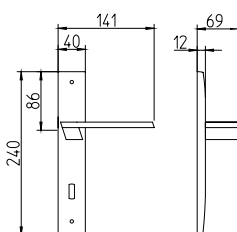

1372/M
cremonese
window lever handle

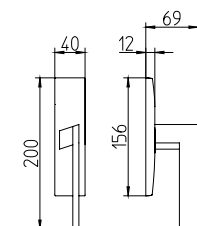

1372/DK
martellina dk
drehkipp system

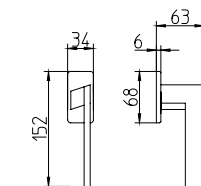

1461
maniglia per porta con rosetta
door handle on rose

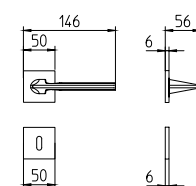

1460
con piastra
on backplate

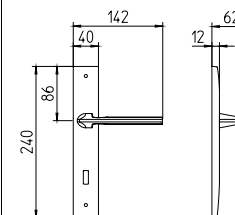

1462/M
cremonese
window lever handle

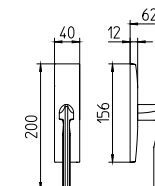

1462/DK
martellina dk
drehkipp system

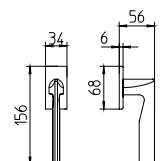

kuki



1741
maniglia per porta con rosetta
door handle on rose

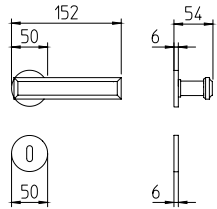

1740
con piastra
on backplate

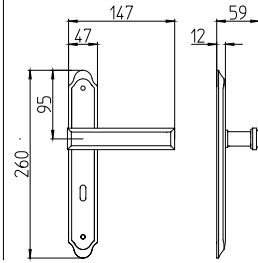

1742/M
cremonese
window lever handle

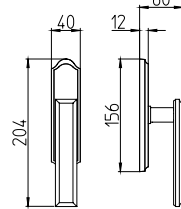

1742/DK
martellina dk
drehkipp system

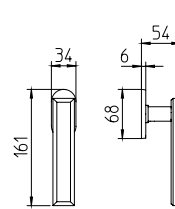

lario



1681
maniglia per porta con rosetta
door handle on rose

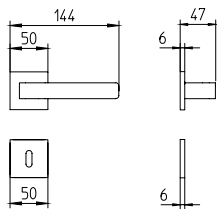

1682/M
cremonese
window lever handle

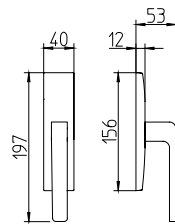

1682/DK
martellina dk
drehkipp system

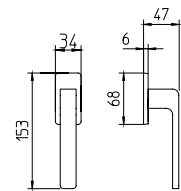

1682/DK-SIC
martellina dk
drehkipp system

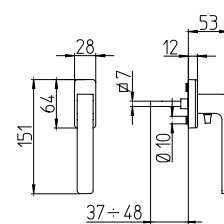

led



1091
maniglia per porta con rosetta
door handle on rose

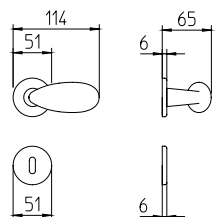

1090
con piastra
on backplate

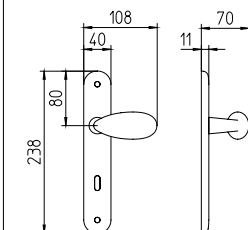

life



1171
maniglia per porta con rosetta
door handle on rose

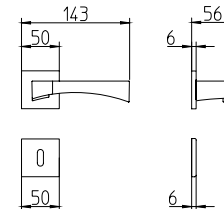

1170
con piastra
on backplate

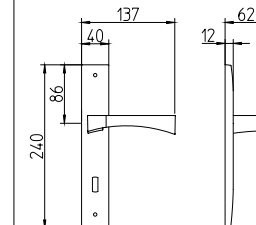

1172/M
cremonese
window lever handle

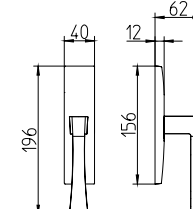

1172/DK
martellina dk
drehkipp system

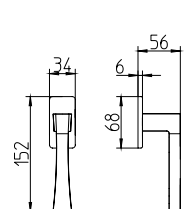

link



1031
maniglia con rosetta
door handle on rose

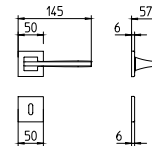

1030
con piastra
on backplate

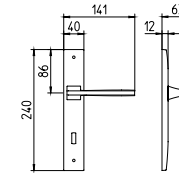

1032/M
cremonese
window lever handle

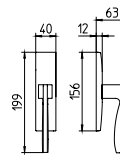

1032/DK
martellina dk
drehkipp system

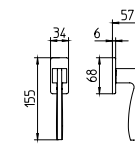

1032/DK-Sic
martellina dk
drehkipp system

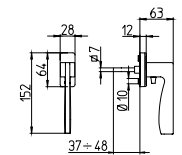

lord



1021
maniglia per porta con rosetta
door handle on rose

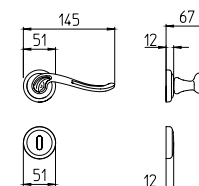

1020
con piastra
on backplate

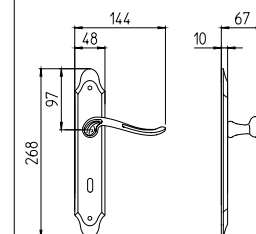

1022/M
cremonese
window lever handle

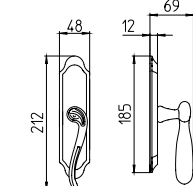

1022/DK
martellina dk
drehkipp system

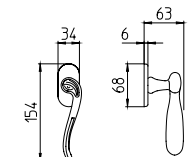

melody



1201
maniglia per porta con rosetta
door handle on rose

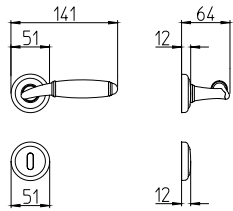

1200
con piastra
on backplate

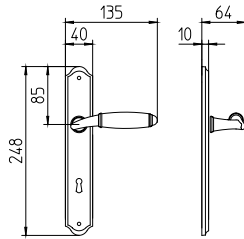

1202/M
cremonese
window lever handle

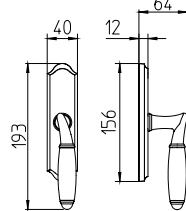

1202/DK
martellina dk
drehkipp system

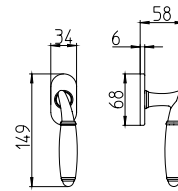

mitos



1131
maniglia per porta con rosetta
door handle on rose

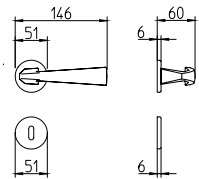

1130
con piastra
on backplate

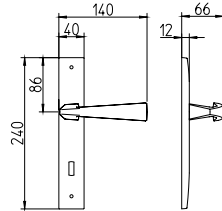

1132/M
cremonese
window lever handle

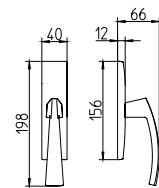

1132/DK
martellina dk
drehkipp system

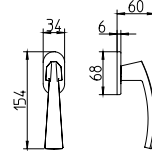

MM80

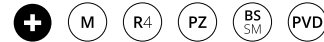

1921
maniglia per porta con rosetta
door handle on rose

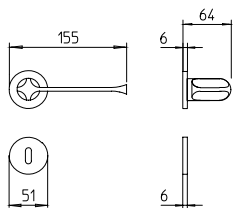

1922/DK
martellina dk
drehkipp system

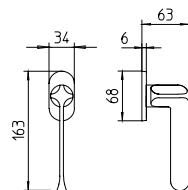

nadir



771
maniglia per porta con rosetta
door handle on rose

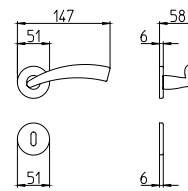

770
con piastra
on backplate

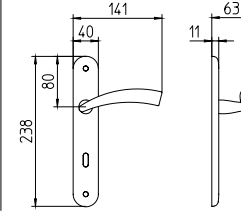

772/M
cremonese
window lever handle

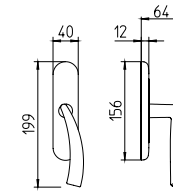

772/DK
martellina dk
drehkipp system

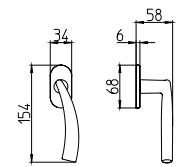

naxos



8011
maniglia per porta con rosetta
door handle on rose

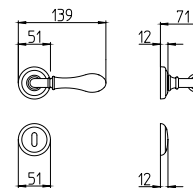

8010
con piastra
on backplate

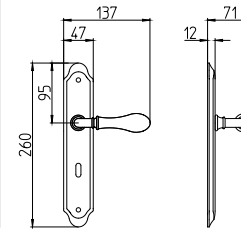

8012/M
cremonese
window lever handle

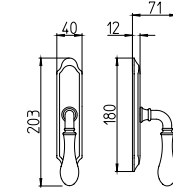

8012/DK
martellina dk
drehkipp system

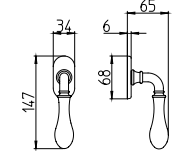

norma



1211
maniglia per porta con rosetta
door handle on rose

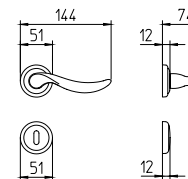

1210
con piastra
on backplate

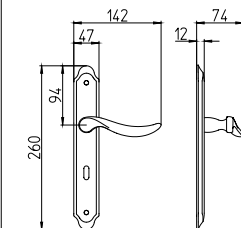

1212/M
cremonese
window lever handle

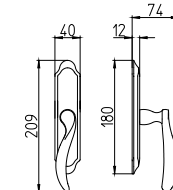

1212/DK
martellina dk
drehkipp system

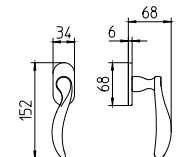

nuria



1501
maniglia per porta con rosetta
door handle on rose

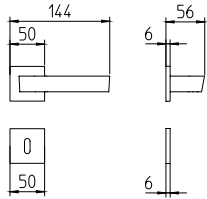

1500
con piastra
on backplate

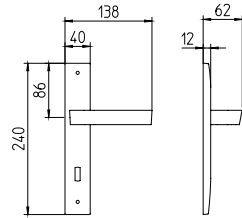

1502/M
cremonese
window lever handle

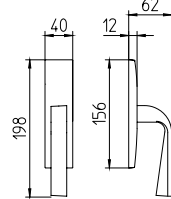

1502/DK
martellina dk
drehkipp system

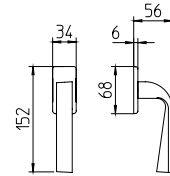

ola



1071
maniglia per porta con rosetta
door handle on rose

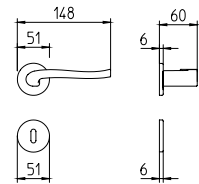

1070
con piastra
on backplate

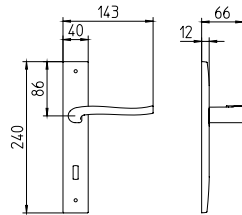

1072/M
cremonese
window lever handle

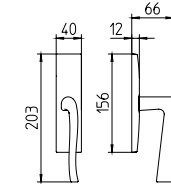

1072/DK
martellina dk
drehkipp system

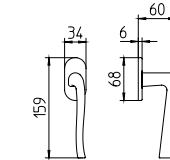

paros



8001
maniglia per porta con rosetta
door handle on rose

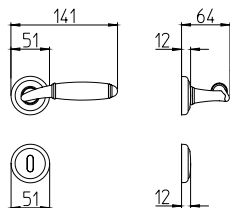

8000
con piastra
on backplate

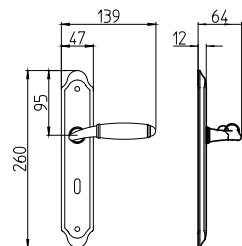

8002/M
cremonese
window lever handle

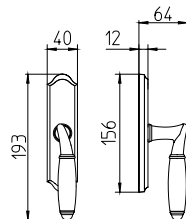

8002/DK
martellina dk
drehkipp system

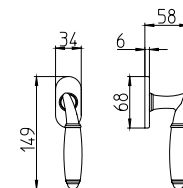

pyramid



1251
maniglia per porta con rosetta
door handle on rose

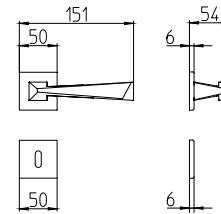

1250
con piastra
on backplate

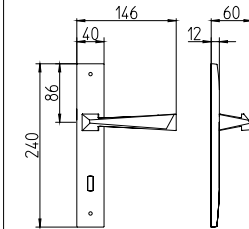

1252/M
cremonese
window lever handle

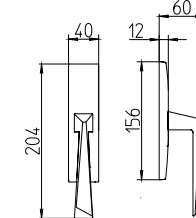

1252/DK
martellina dk
drehkipp system

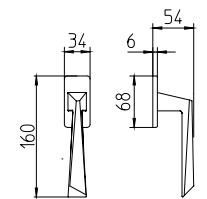

plissé



981
maniglia per porta con rosetta
door handle on rose

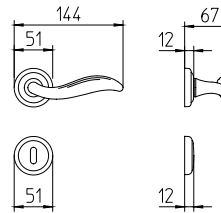

980
con piastra
on backplate

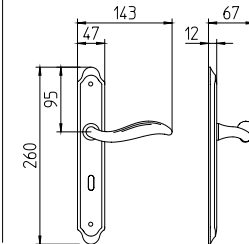

982/M
cremonese
window lever handle

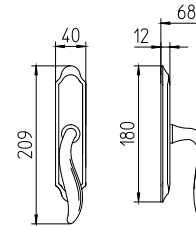

982/DK
martellina dk
drehkipp system

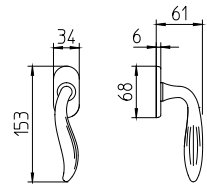

PP33



1801
maniglia per porta con rosetta
door handle on rose

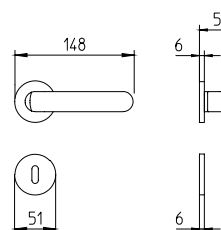

1800
con piastra
on backplate

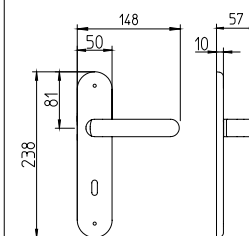

1802/M
cremonese
window lever handle

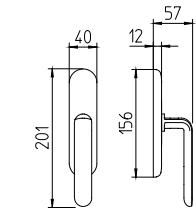

1802/DK
martellina dk
drehkipp system

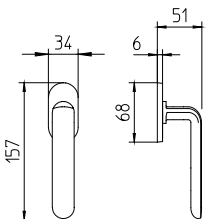

river



991
maniglia per porta con rosetta
door handle on rose

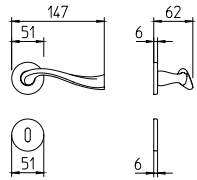

990
con piastra
on backplate

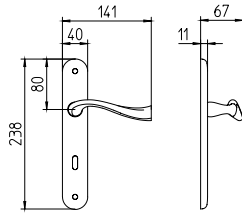

992/M
cremonese
window lever handle

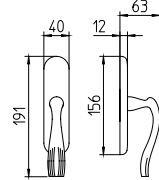

992/DK
martellina dk
drehkipp system

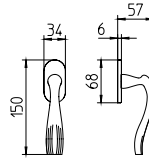

rondò



691
maniglia per porta con rosetta
door handle on rose

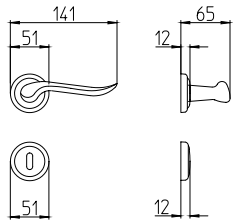

690
con piastra
on backplate

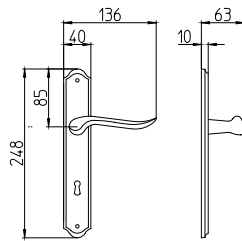

692/M
cremonese
window lever handle

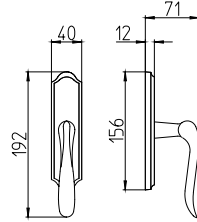

692/DK
martellina dk
drehkipp system

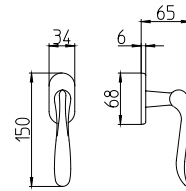

seven



1761
maniglia per porta con rosetta
door handle on rose

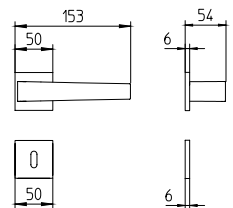

1762/M
cremonese
window lever handle

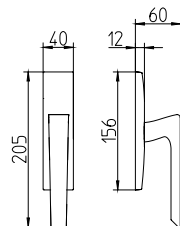

1762/DK
martellina dk
drehkipp system

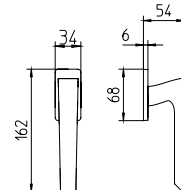

sevilla



531
maniglia per porta
con rosetta
door handle on rose

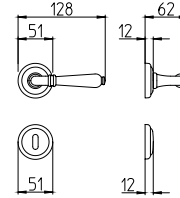

530
con piastra
on backplate

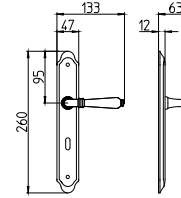

532/M
cremonese
window lever handle

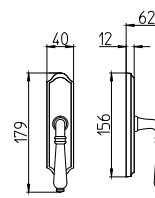

532
cremonese centrale
central window lever

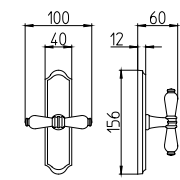

532/DK
martellina dk
drehkipp system

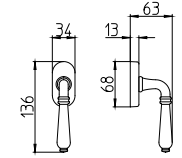

special



S91
maniglia per porta con rosetta
door handle on rose

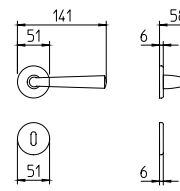

S90
con piastra
on backplate

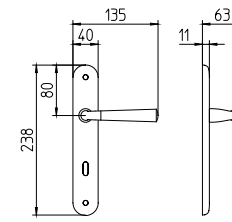

S92/M
cremonese
window lever handle

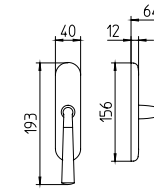

S92/DK
martellina dk
drehkipp system

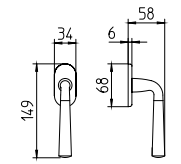

spin



731
maniglia per porta con rosetta
door handle on rose

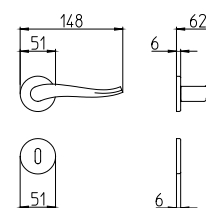

730
con piastra
on backplate

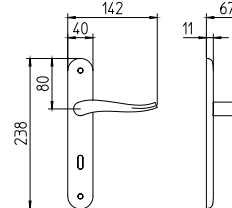

732/M
cremonese
window lever handle

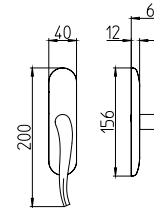

732/DK
martellina dk
drehkipp system

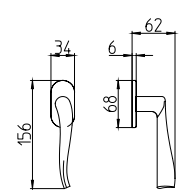

start



S101
maniglia con rosetta
door handle on rose

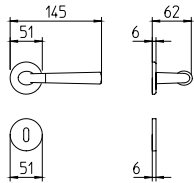

S100
con piastra
on backplate

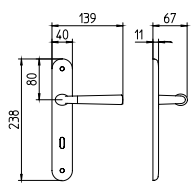

S102/M
cremonese
window lever handle

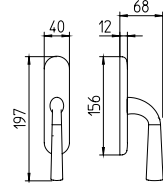

S102/DK
martellina dk
drehkipp system

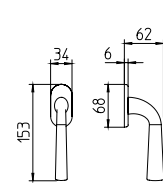

S102/DKM-SIC
martellina dk
drehkipp system

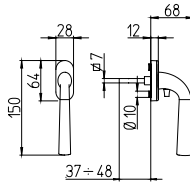

telis



1161
maniglia per porta con rosetta
door handle on rose

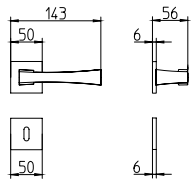

1160
con piastra
on backplate

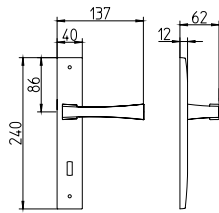

1162/M
cremonese
window lever handle

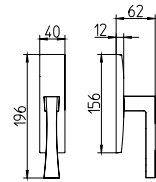

1162/DK
martellina dk
drehkipp system

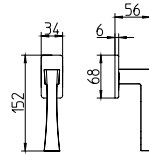

totem



461
maniglia per porta con rosetta
door handle on rose

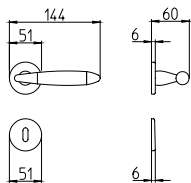

460
con piastra
on backplate

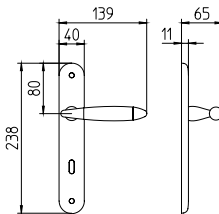

462/M
cremonese
window lever handle

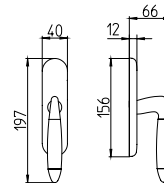

462/DK
martellina dk
drehkipp system

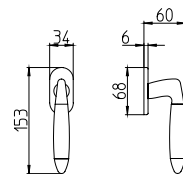

tuc



361
maniglia per porta con rosetta
door handle on rose

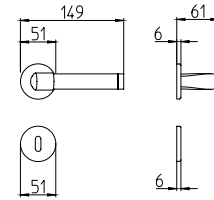

360
con piastra
on backplate

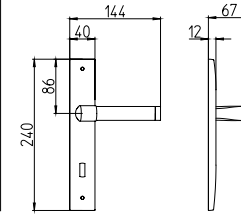

362/M
cremonese
window lever handle

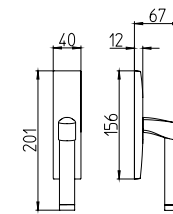

362/DK
martellina dk
drehkipp system

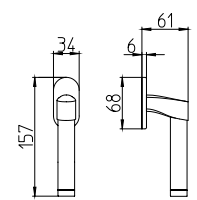

twee



1691
maniglia per porta con rosetta
door handle on rose

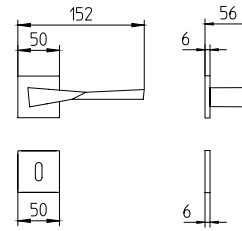

1692/M
cremonese
window lever handle

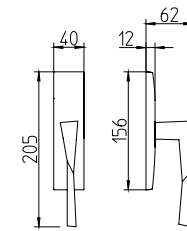

1692/DK
martellina dk
drehkipp system

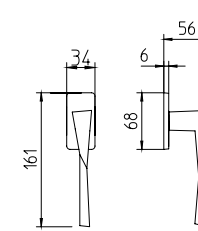

virgo



1651
maniglia per porta con rosetta
door handle on rose

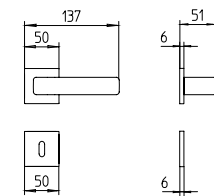

1652/DK
martellina dk
drehkipp system

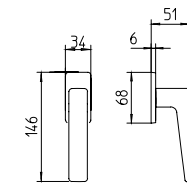

zante



1301
maniglia per porta con rosetta
door handle on rose

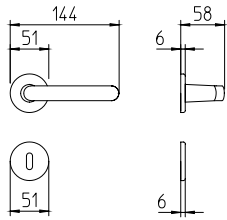

1300
con piastra
on backplate

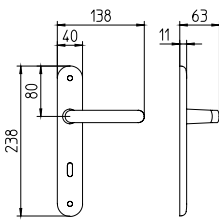

1302/M
cremonese
window lever handle

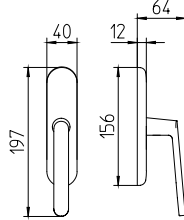

1302/DK
martellina dk
drehtipp system

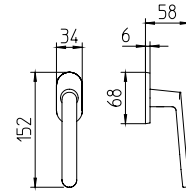

zeit



1721
maniglia per porta con rosetta
door handle on rose

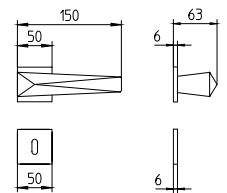

1722/M
cremonese
window lever handle

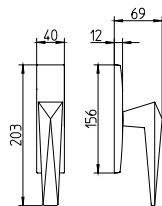

1722/DK
martellina dk
drehtipp system

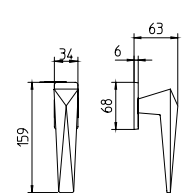

zen



711
maniglia per porta con rosetta
door handle on rose

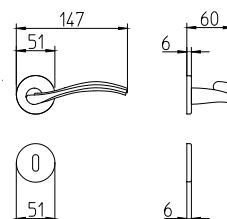

710
con piastra
on backplate

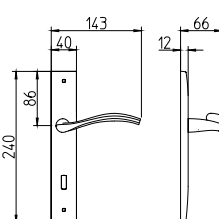

712/M
cremonese
window lever handle

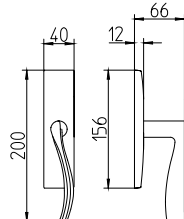

712/DK
martellina dk
drehtipp system

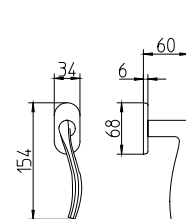

zoe



381
maniglia per porta con rosetta
door handle on rose

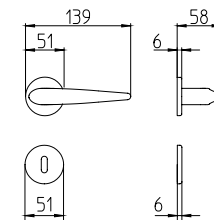

380
con piastra
on backplate

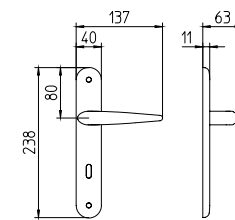

382/M
cremonese
window lever handle

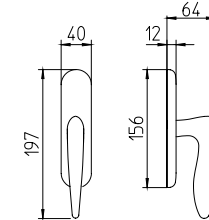

382/DK
martellina dk
drehtipp system

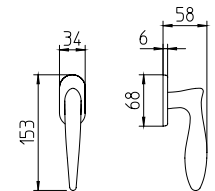

zoom



351
maniglia per porta con rosetta
door handle on rose

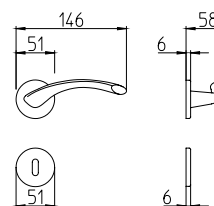

350
con piastra
on backplate

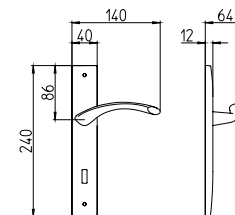

352/M
cremonese
window lever handle

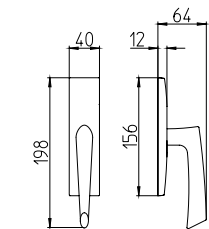

352/DK
martellina dk
drehtipp system

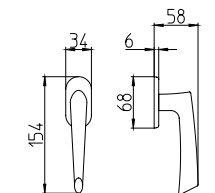

160R

160/R DX-SX

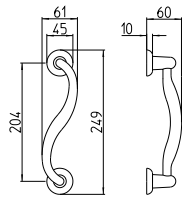

160/R-C

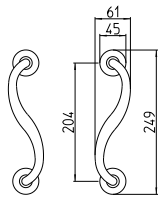

160/R-P

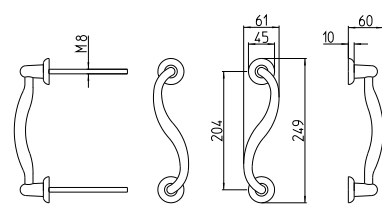

1035

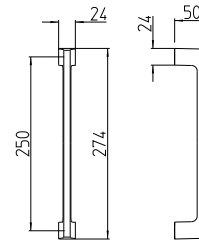

1125

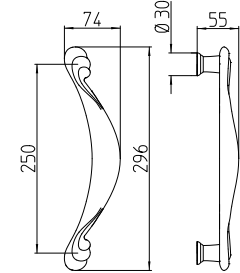

465

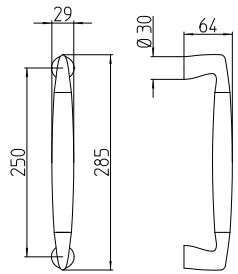

465/L

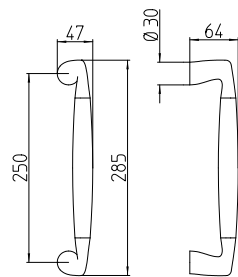

1255

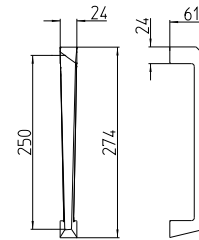

1305

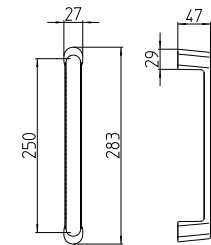

775

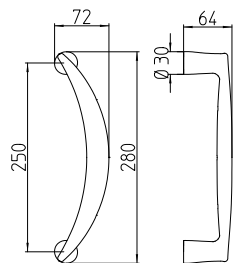

995

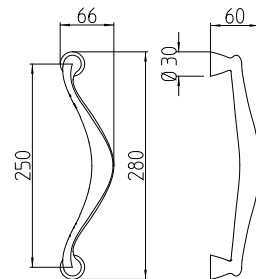

1315

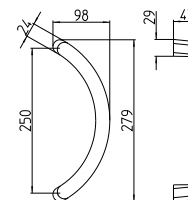

1725

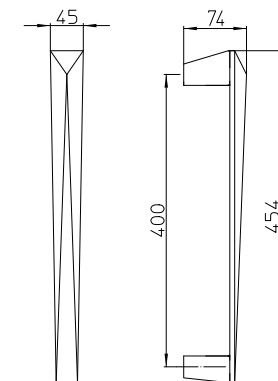

1675

1675-1000
SX DX

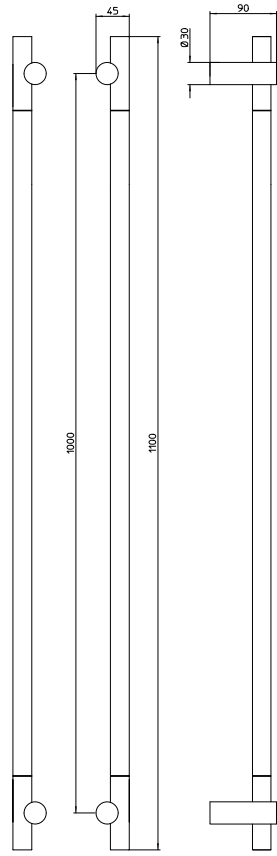

1675-250
SX DX

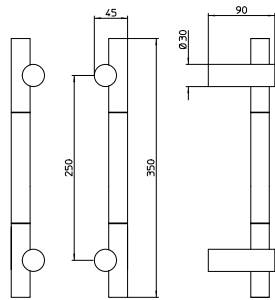

Art. 1675 su misura da 250 mm a 1000 mm / size on request

1675S

1675S-700
SX DX

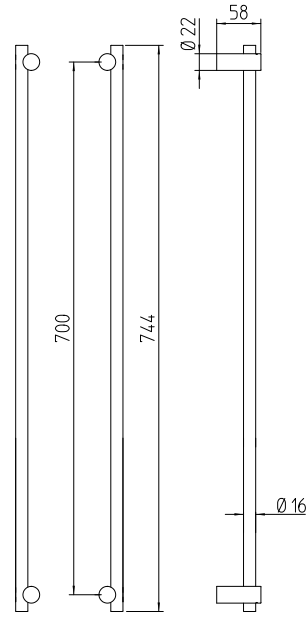

1675S-200
SX DX

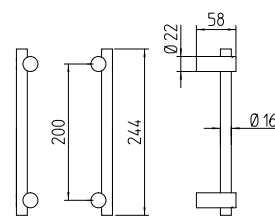

Art. 1675S su misura da 200 mm a 700 mm / size on request

1735

1735-1000

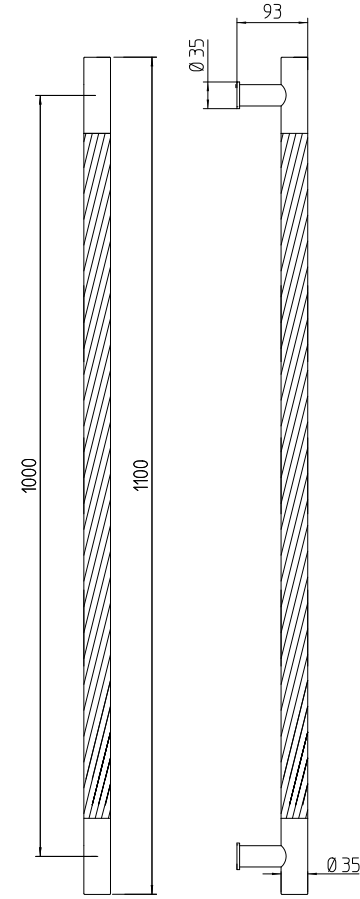

1735-400

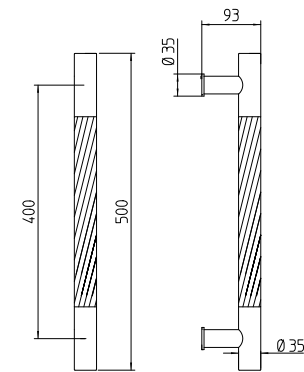

Art. 1735 su misura da 400 mm a 1000 mm / size on request

1735S

1735S-700

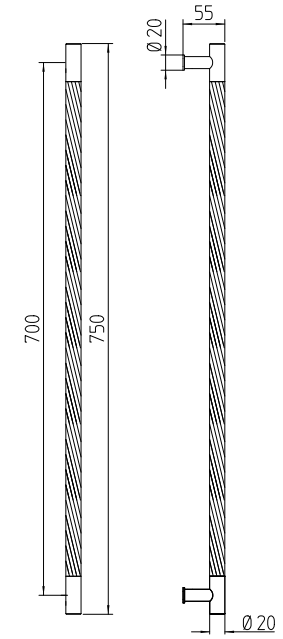

1735S-200

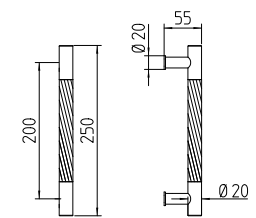

Art. 1735S su misura da 200 mm a 700 mm / size on request

1785

1785-1000

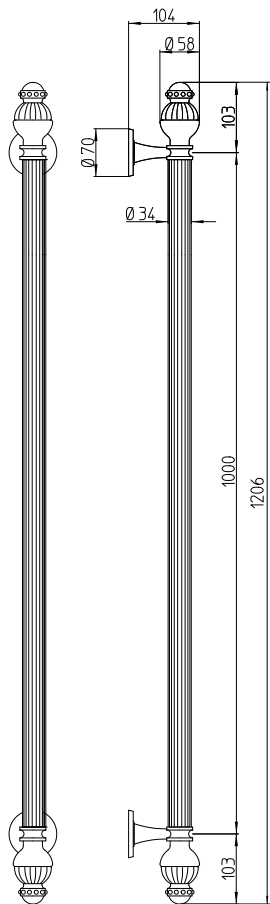

1785-400

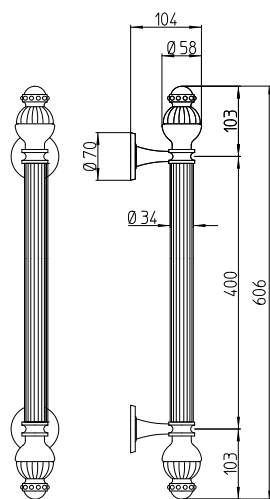

Art. 1785 su misura da 400 mm a 1000 mm / size on request

3025

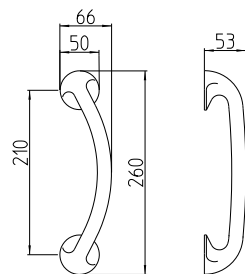

1965

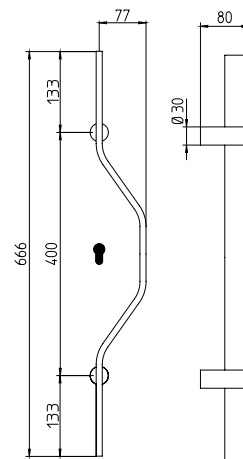
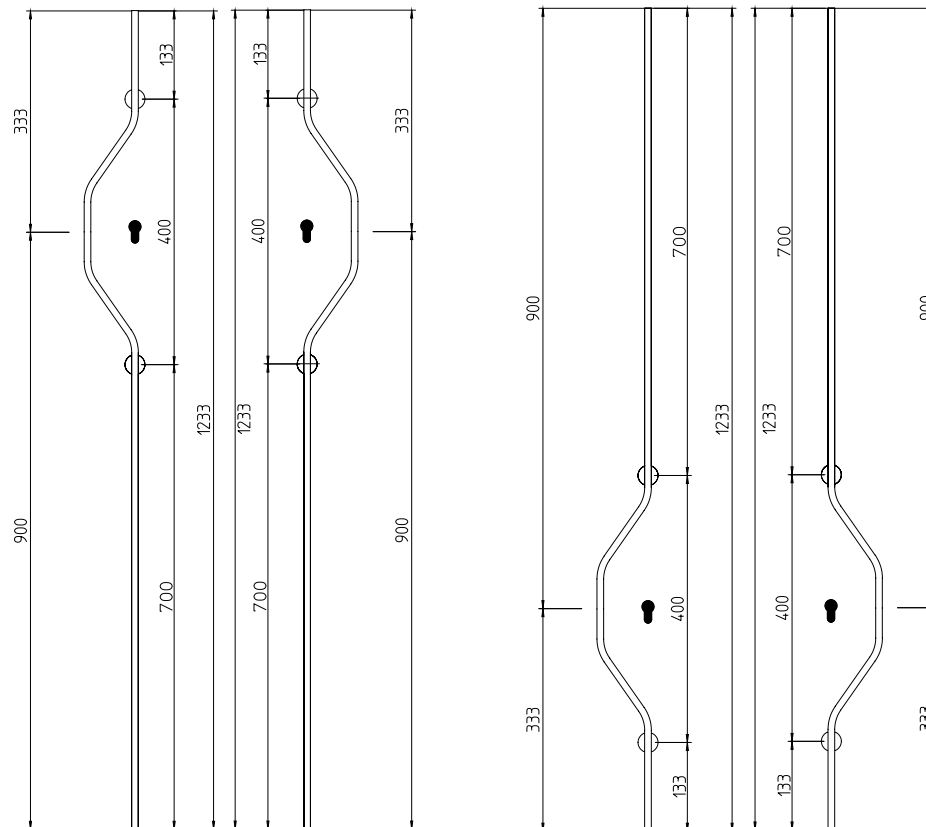

195



195/A

Per alzante scorrevole con maniglia ad incasso (con/senza foro cilindro) impugnatura 233-10 mm

Mechanism pull-up handle for sliding door with flush handle (with/without key-hole cylinder) pull length 233-10 mm

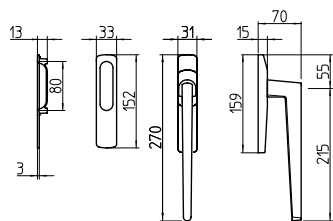

196

196/A

Alzante scorrevole con maniglia ad incasso (con/senza foro cilindro) impugnatura 24-10 mm.

Mechanism pull-up handle for sliding door with flush handle (with/without key-hole cylinder) pull length 24-10 mm

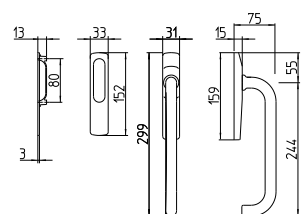

196/C

Alzante scorrevole con maniglia ad incasso (con/senza foro cilindro) lunghezza impugnatura 179-10 mm

Mechanism pull-up handle for sliding door with flush handle (with/without key-hole cylinder) Pull length 179-10 mm

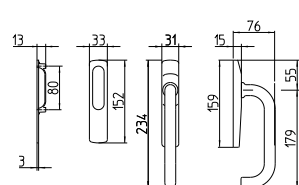

195/A-P

Per alzante scorrevole a coppia (con/senza foro cilindro) impugnatura 233-10 mm

Mechanism pull-up handle pair (with/without key-hole cylinder) pull length 233-10 mm

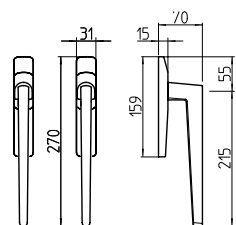

196/A-P

Alzante scorrevole a coppia (con/senza foro cilindro) impugnatura 24-10 mm

Mechanism pull-up handle pair (with/without key-hole cylinder) pull length 24-10 mm

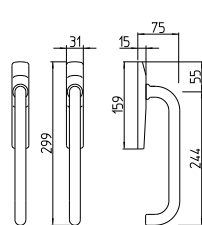

196/C-P

Maniglione alzante scorrevole a coppia (con/senza foro cilindro) lunghezza impugnatura 179-10 mm

Mechanism pull-up handle pair (with/without key-hole cylinder) pull length 179-10 mm

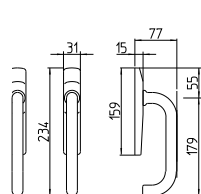

197



197/A

Alzante scorrevole con maniglia ad incasso (con/senza foro cilindro) impugnatura 233-10 mm

Mechanism pull-up handle for sliding door with flush handle (with/without key-hole cylinder) pull length 233-10 mm

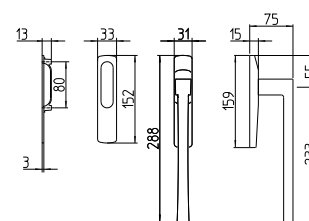

198



198/A

Alzante scorrevole con maniglia ad incasso (con/senza foro cilindro) impugnatura 233-10 mm

Mechanism pull-up handle for sliding door with flush handle (with/without key-hole cylinder) pull length 233-10 mm

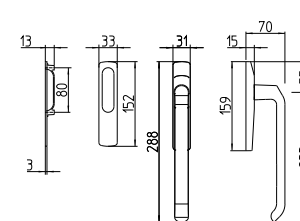

197/A-P

Alzante scorrevole a coppia (con/senza foro cilindro) impugnatura 233-10 mm

Mechanism pull-up handle pair (with/without key-hole cylinder) pull length 233-10 mm

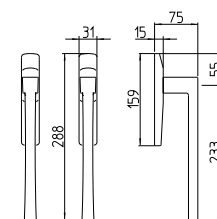

198/A-P

Alzante scorrevole a coppia (con/senza foro cilindro) impugnatura 233-10 mm

Mechanism pull-up handle pair (with/without key-hole cylinder) pull length 233-10 mm

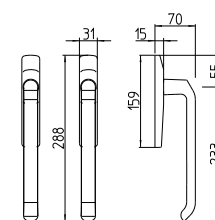

196/B

Maniglione DK impugnatura 158-7 mm
Pull-up handle DK for sliding door pull length 158-7 mm

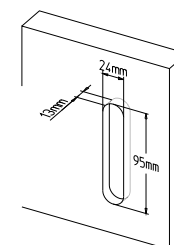
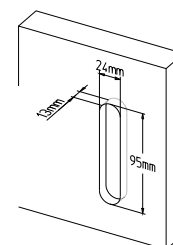
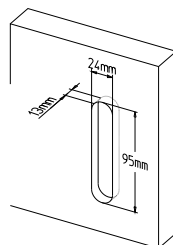
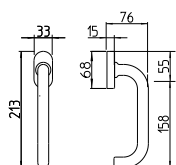
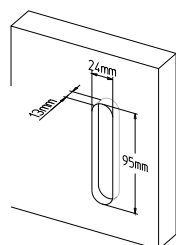

368 T

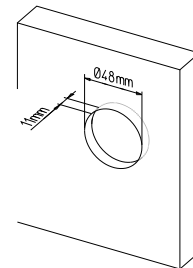
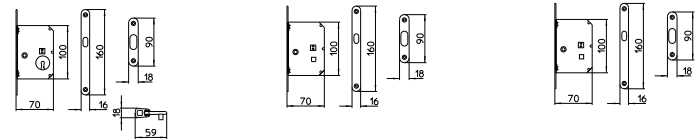
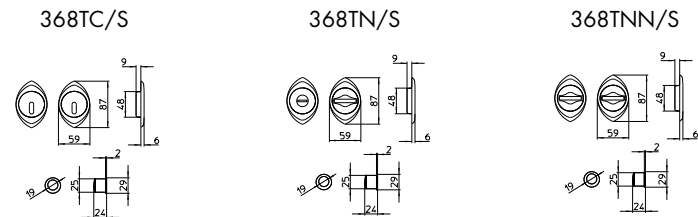
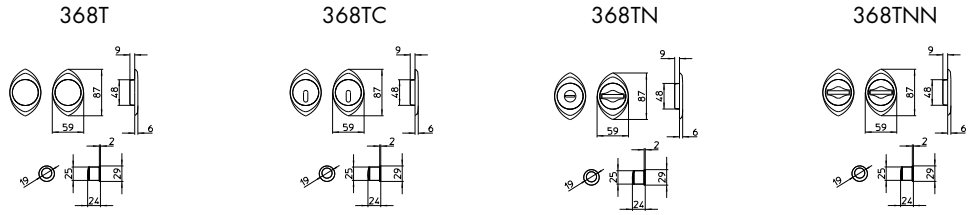

1018 T

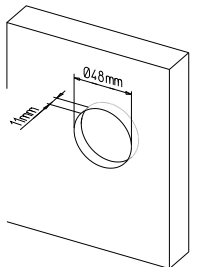
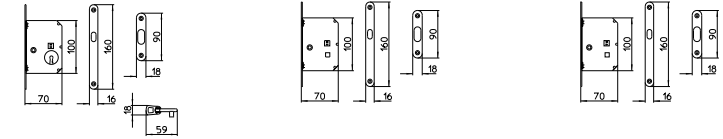
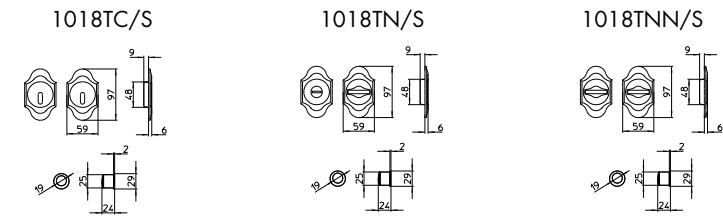
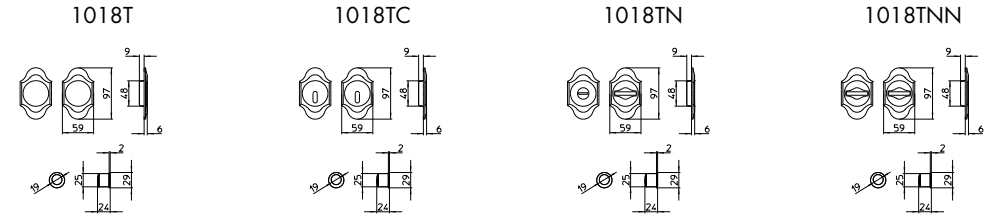

378

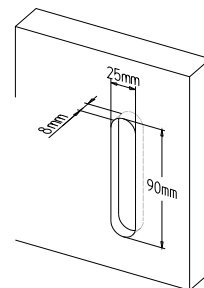
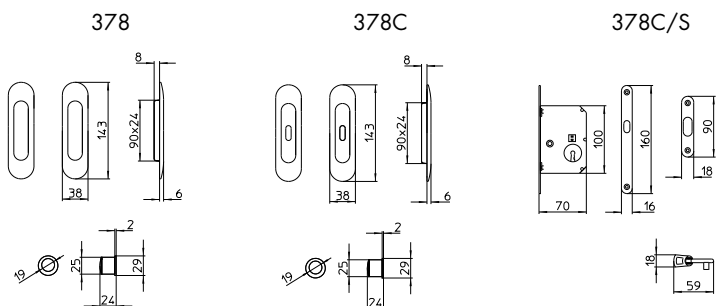

1028 T

1028T

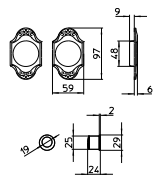

1028TC

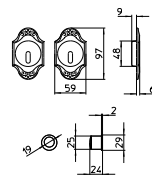

1028TN

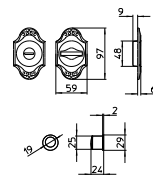

1028TNN

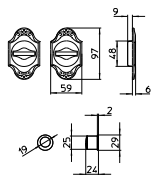

1028TC/S

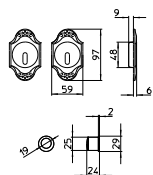

1028TN/S

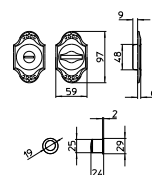

1028TNN/S

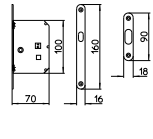
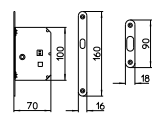
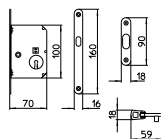
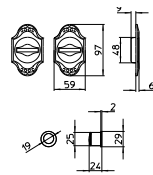

1028TL

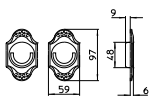

1028TLN

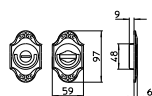

1028TLN/S

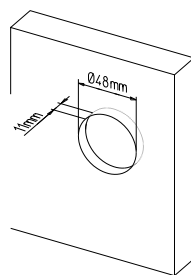
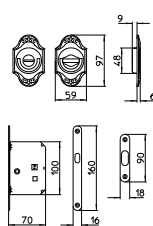

1028

1028

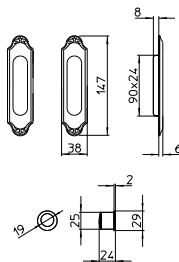

1028C

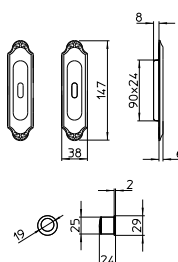

1028C/S

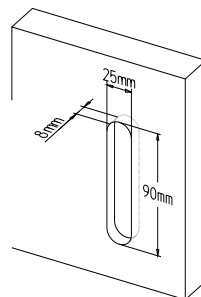
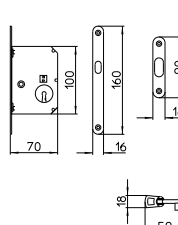

1038 T

1038T

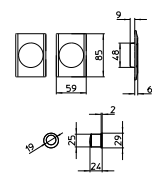

1038TC

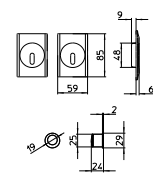

1038TN

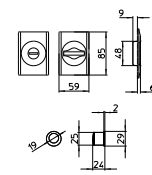

1038TNN

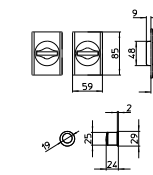

1038TC/S

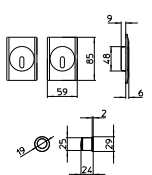

1038TN/S

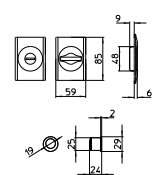

1038TNN/S

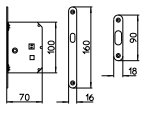
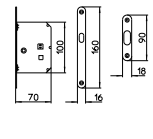
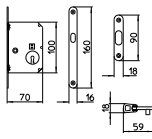
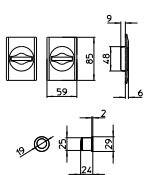

1038TL

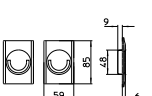

1038TLN

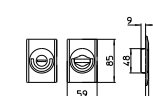

1038TLN/S

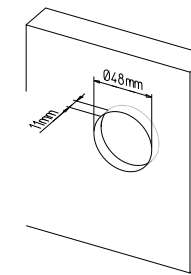
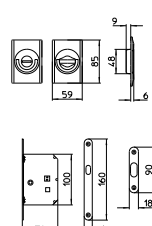

1038

1038

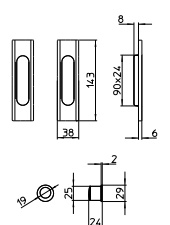

1038C

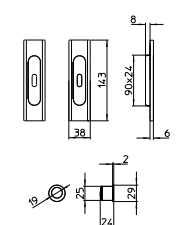

1038C/S

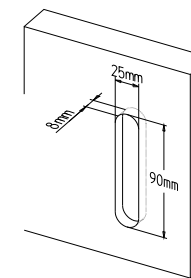
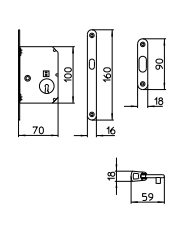

1108 T

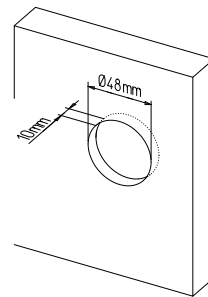
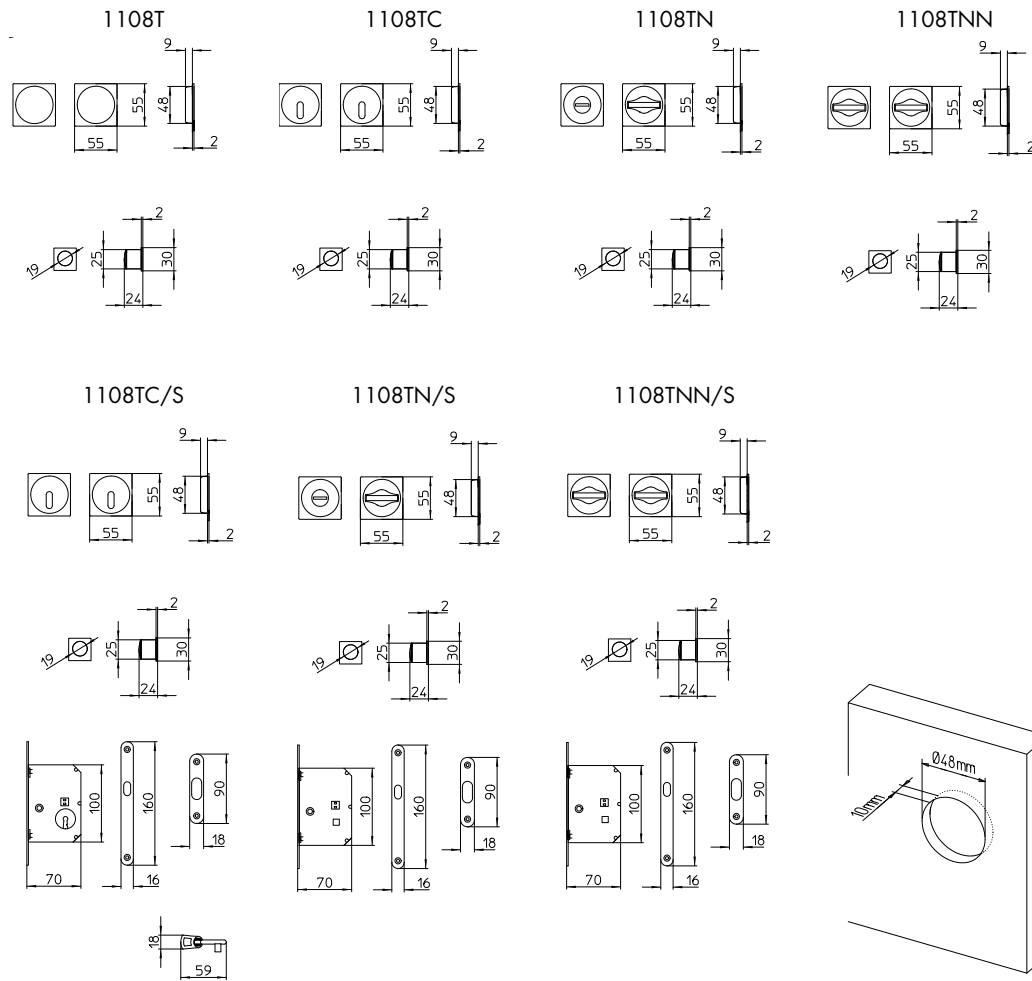

1118 T

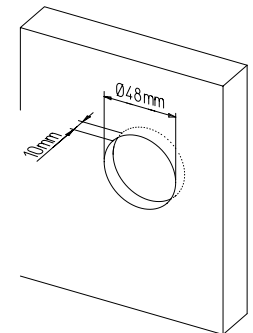
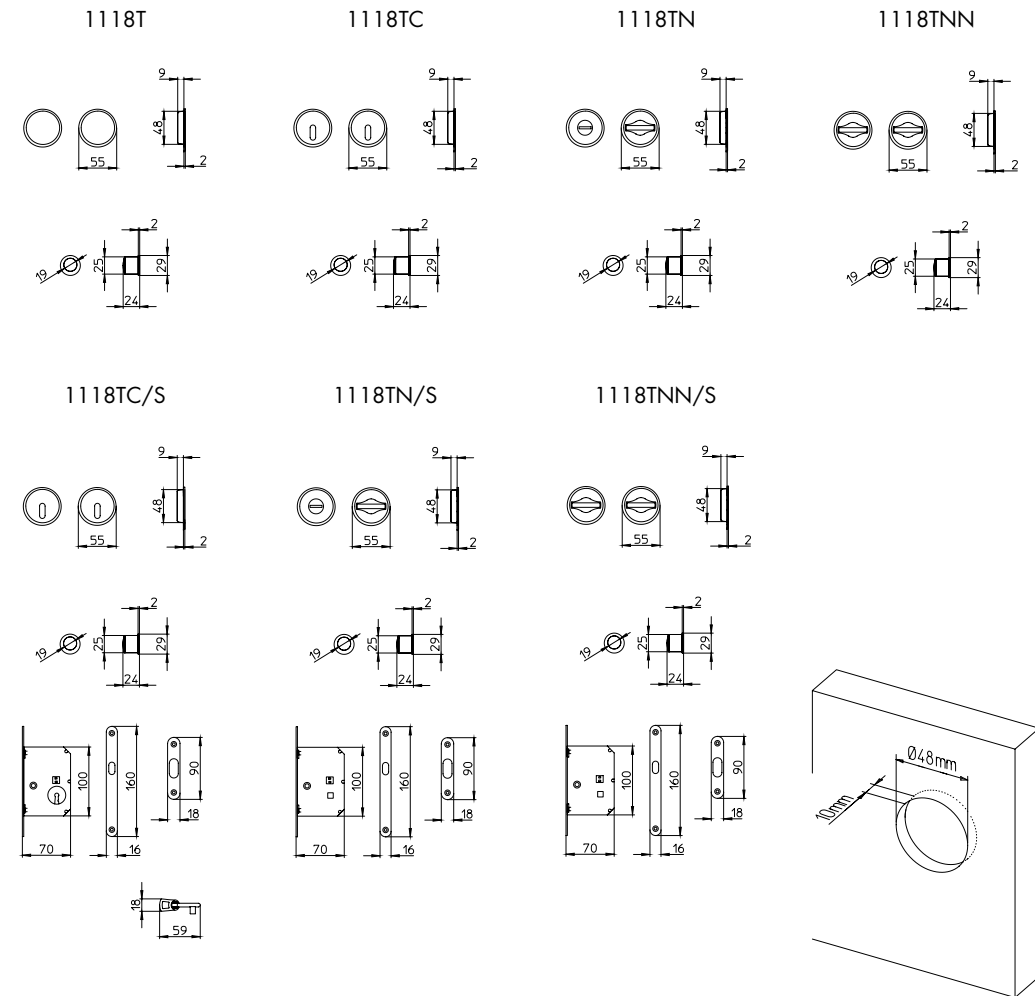

284

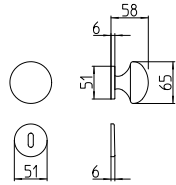

Disponibile anche in versione fissa
/ Also available in a fixed version

644

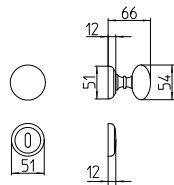

Disponibile anche in versione fissa
/ Also available in a fixed version

744

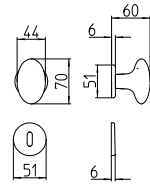

Disponibile anche in versione fissa
/ Also available in a fixed version

651-113



RFV

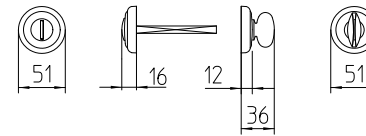

1351-113

RFV-RW

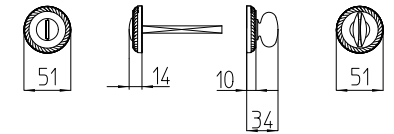

854

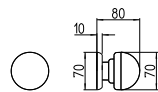

854/GIR

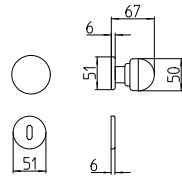

1104

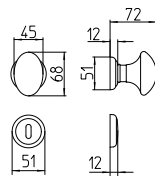

911-114



RFV

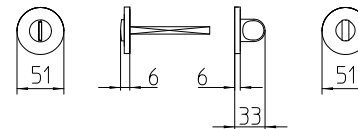

RFV-RW

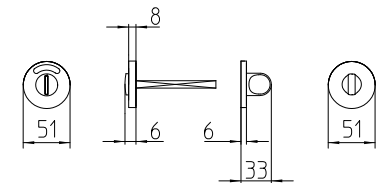

1024/A

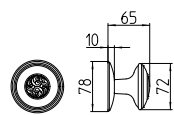

1024/B

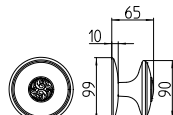

1024/GIR

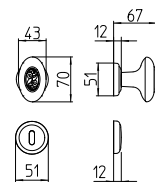

Disponibile anche in versione fissa
/ Also available in a fixed version

1291-115



RFV

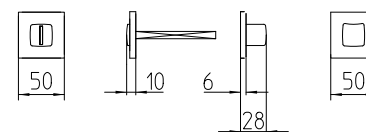

RFV-RW

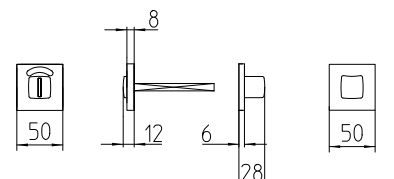

3040

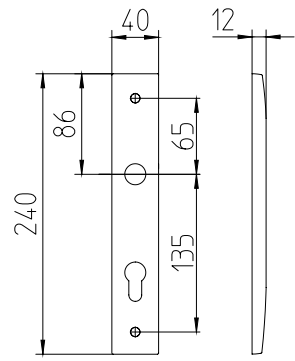

440

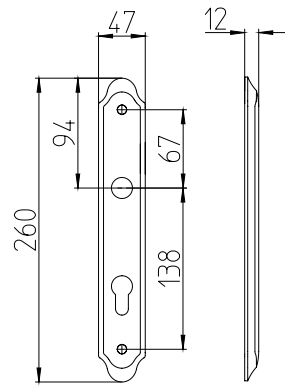

1020

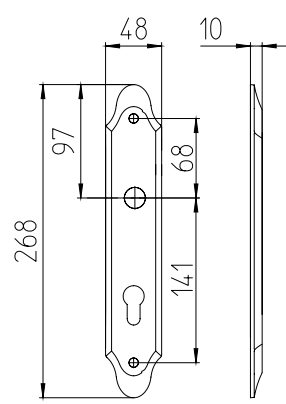

S40

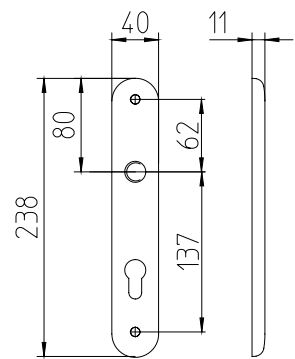

1350

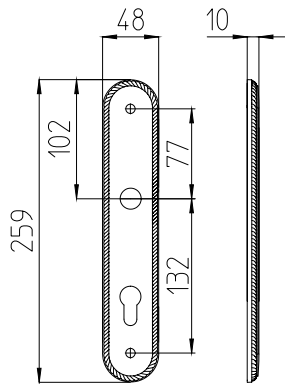

bocchette / escutcheons

651

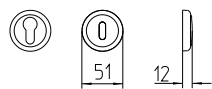

911

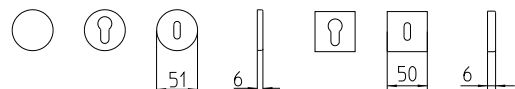

1291

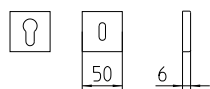

1351

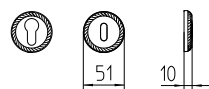

6061

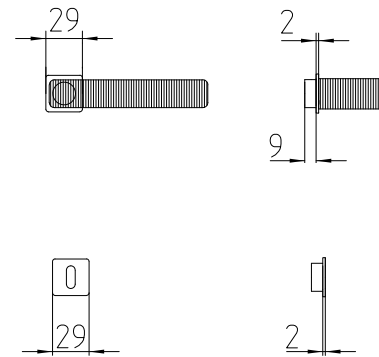

6071

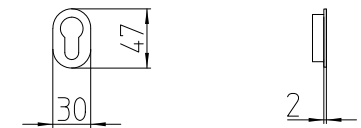
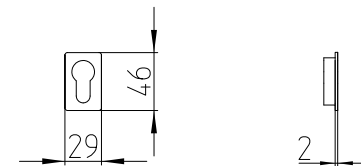
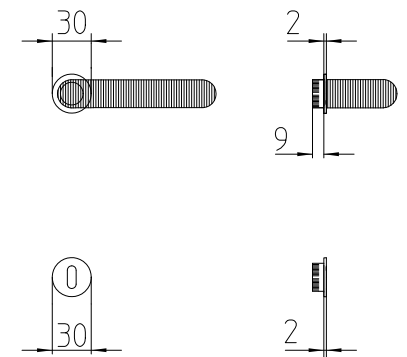

221



BS



BS/Y



231

⊕ PVD



BSQ

⊕ PVD



BSQ/Y

⊕ PVD



Z

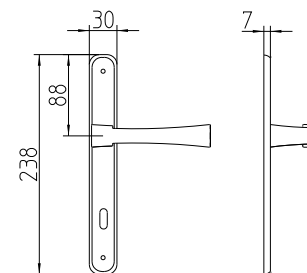

Z/Y

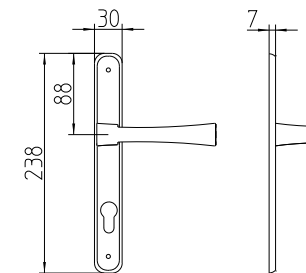

australia

⊕

PRIVACY

PASSAGE

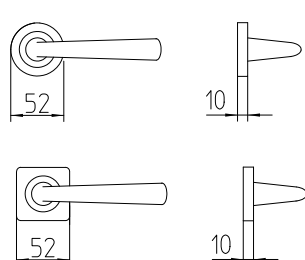
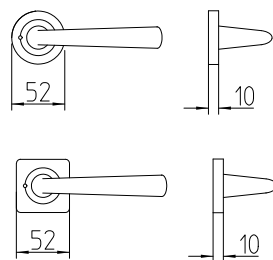

P48

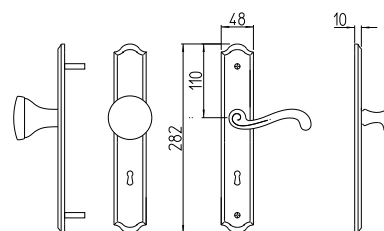

P55

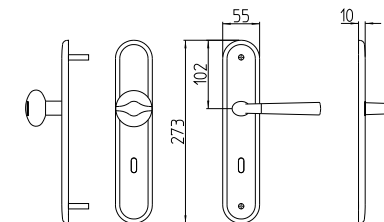

911-DB

⊕ PVD

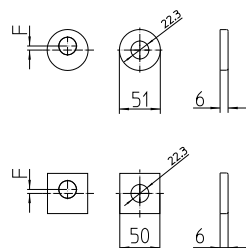

690-SIC

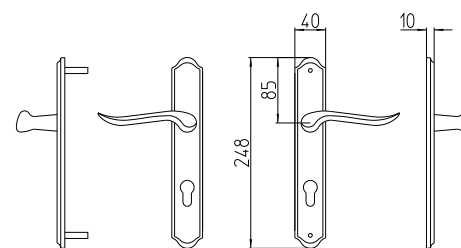

3040-SIC

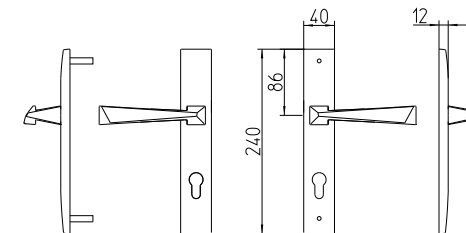

690UP

+ PVD

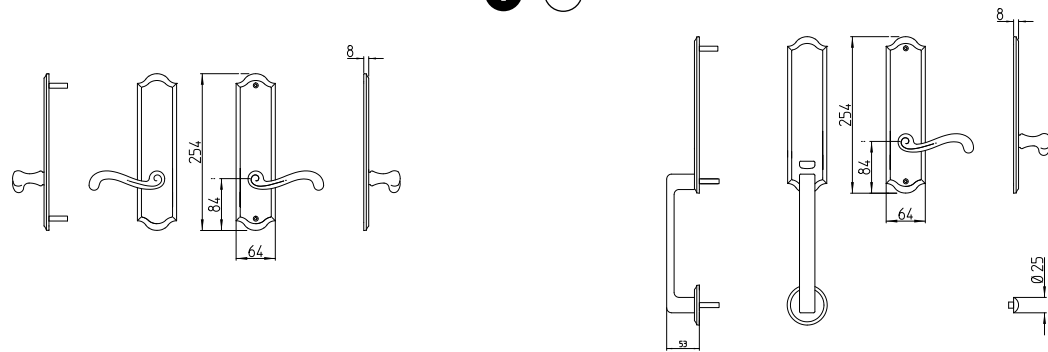

1700UP

+ PVD

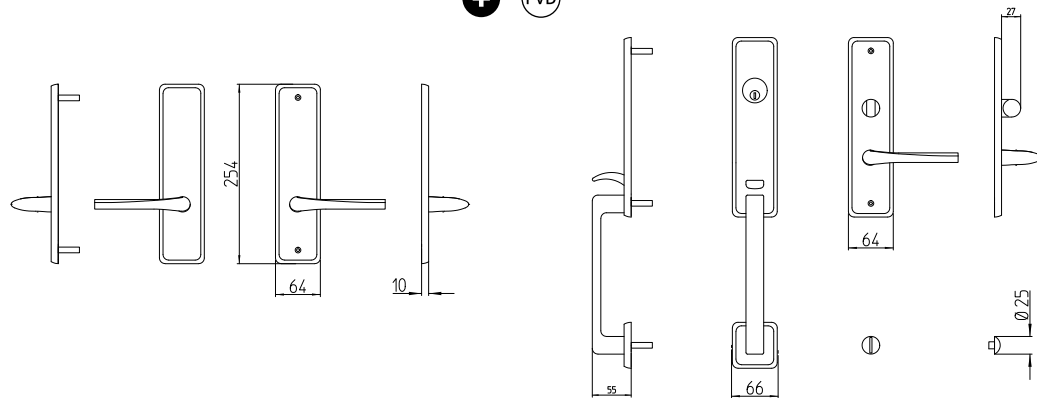

1710UP

+ PVD

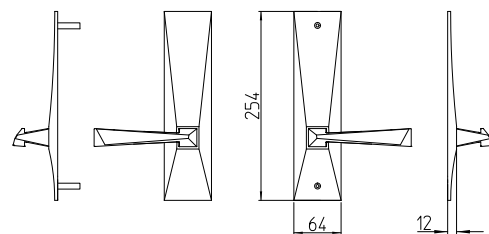

6031US

911US



fermaporte / doorstop

109

+ PVD

110-55

+ PVD

110-68

+ PVD

111

+ PVD

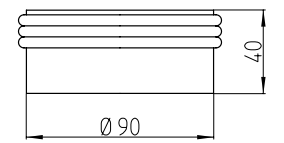
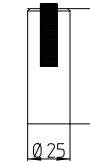
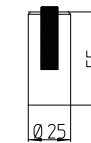
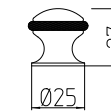

1987

+ PVD

1987-68

+ PVD

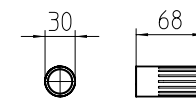
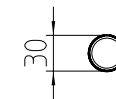
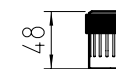

appendiabiti / clothes hook

1989

+ PVD

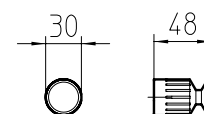

Garanzia. Grazie alla qualità dei materiali impiegati ed all'elevata tecnologia di produzione, MANDELLI1953 offre una speciale garanzia. Il periodo viene esteso, a decorrere dalla data di acquisto, in base alle finiture.

- 26 - 26D: 4 anni;
- Fluxcoating (MBR, AB, 28, MSN): 5 anni;
- PVD: 30 anni.
- La garanzia per i le finiture/materiali non specificati è di 1 Anno
- Avvertenza : Pulire i nostri prodotti solamente con un panno umido d'acqua.

A discrezione di MANDELLI1953, è prevista la riparazione o la sostituzione gratuita del prodotto considerato difettoso entro il periodo di garanzia. Qualora il prodotto sia stato nel frattempo eliminato dalla produzione, MANDELLI1953 potrà, a sua discrezione, decidere se sostituire la merce difettosa con prodotti simili o se rimborsare il costo originario dei prodotti. L'accertamento delle cause, delle responsabilità e la presenza di eventuali vizi di produzione sarà ad insindacabile giudizio di MANDELLI1953. Le spese di invio del campione per tale valutazione sono a carico dell'acquirente. Accertata la responsabilità di MANDELLI1953 e il rispetto dei termini di garanzia, le spese di invio di ulteriore materiale e la restituzione degli stessi riparati o in sostituzione saranno a carico di MANDELLI1953, la stessa non sarà in alcun caso responsabile per i costi relativi all'installazione, riparazione e sostituzione come di danni o perdite lamentate.

Guarantee. The high quality of the technology and production processes means that MANDELLI1953 offers special guarantees. The extended guarantee period runs from the date of purchase, the term depending on the type of finish.

- 26 - 26D: 4 years;
- Fluxcoating (MBR, AB, 28, MSN): 5 years;
- PVD: 30 years.
- The warranty for non-specified finishes / materials is 1 year
- Warning: Clean our products only with a damp cloth.

The guarantee provides, at the discretion of MANDELLI1953, for repairs to or the free replacement of the product deemed defective within the guarantee period. If the product has in the meantime gone out of production, MANDELLI1953 may, at its discretion, decide to replace the defective goods with similar products, or to reimburse the customer the original cost. Ascertaining the causes of, responsibility for and the presence of any production process defects, are matters for the final judgement of MANDELLI1953. The costs of sending the sample for appraisal shall be borne by the purchaser. When the responsibility of MANDELLI1953 has been ascertained and the guarantee terms are complied with, the costs of sending any further goods and the return of repaired good or replacement goods shall be borne by MANDELLI1953, while the company shall in no case be liable for costs relating to installation, repair or replacement or for damages or losses complained of.



Solo ottone e acciaio. Niente altri materiali più facilmente soggetti all'usura del tempo. I sistemi di sicurezza delle maniglie MANDELLI1953 sono fatti per durare nel tempo. I pulsanti di blocco alla rotazione sono collocati discretamente sul retro dell'impugnatura per non alterare le linee del prodotto. La sicurezza, sia dall'interno che dall'esterno, non sacrifica la funzionalità: il sistema è ergonomico e facile da azionare per un adulto. Basta una leggera pressione sul tasto per sbloccare la rotazione e azionare la maniglia. Sicurezza non solo per la casa ma anche per i bambini. Il DK magnetico di sicurezza è disponibile solo sui modelli Lario, Link e Start.

Only brass and steel. No any other materials likely to wear quickly. The MANDELLI1953 handle security systems are made to last forever. They are, moreover, invisible, with the rotation lock buttons discretely hidden at the back of the handle so as not to interfere with their aesthetic look. Inside and outside security remains highly functional, ergonomic and easy to use. Light pressure on the button unlocks rotation to turn the handle. As quick and easy as any quality product should be. The secure magnetic DK-lever-system is available for oval plates on Lario, Link and Start.



1831 - **40+1** p56



451 - **ande** p58



1791 - **aqualung** p60



3191 - **ara** p62



1941 - **aries** p64



1631 - **astrid** p66



1511 - **aurora** p68



1671 - **bilbao** p70



1991 - **câlin** p72



1611 - **callas** p74



1620 - **carré** p76



1984 - **chrono k** p78



1981 - **chrono h** p80



1641 - **cocò** p82



1971 - **coupé** p84



641 - **doge** p86



1291 - **fan** p88



1601 - **fenix** p90



721 - **filo** p92



1871 - **frame** p94



1731 - **fusilla** p96



1421 - **gou** p98



1751 - **grint** p100



1341 - **hartù** p102



1081 - **isi** p104



1371 - **jet** p106



8021 - **juno** p108



1950 - **K** p110



1461 - **kiri** p112



1741 - **kuki** p114



1681 - **lario** p116



1091 - **led** p118



1171 - **life** p120



1031 - **link** p122



1021 - **lord** p124



1201 - **melody** p126



1131 - **mitos** p128



1921 - **MM80** p130



771 - **nadir** p132



8011 - **naxos** p134



1211 - **norma** p136



1501 - **nuria** p138



1071 - **ola** p140



8001 - **paros** p142



1251 - **pyramid** p144



981 - **plissé** p146



1801 - **PP33** p148



1201 - **river** p150



691 - **rondò** p152



1761 - **seven** p154



531 - **sevilla** p156



S91 - **special** p158



731 - **spin** p160



S101 - **start** p162



1161 - **telis** p164



461 - **totem** p166



361 - **tuc** p168



1691 - **twee** p170



1651 - **virgo** p172



1301 - **zante** p174

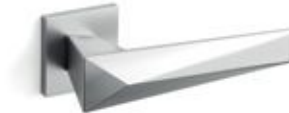

1721 - **zeit** p176



711 - **zen** p178



381 - **zoe** p180



351 - **zoom** p182

Art direction
Lorenzo Butti

CGI
Studio 9010

Printed by
Grafica Gioia, 2023

Il catalogo e i prodotti sono soggetti ad aggiornamenti. Le colorazioni e le raffigurazioni visibili sul catalogo hanno valore puramente indicativo e possono presentare leggere differenze dal prodotto originale in quanto riportate con un procedimento di stampa. Eventuali discordanze tra prodotto finito e rappresentazione non costituiscono motivo di reclamo, essendo l'ordine effettuato l'unico parametro di riferimento. Le quote riportate sono indicative e potrebbero avere lievi differenze date dal fatto che le nostre lavorazioni sono realizzate a mano.

Modelli e marchi depositati. Tutti i diritti riservati © ERCO srl.

Catalogues and products are subject to improvements. Colors and pictures in the catalogue are not binding and may slightly differ if compared with the product since they are obtained by a printing process. Possible differences between ready-made product and its representation cannot cause any complaint, since the purchase order is the only binding reference document. The dimensions reported are indicative and may slightly vary due to the fact that our handles are performed manually.

Models are trade-marks registered. All rights reserved © ERCO srl.

MANDELLI 1953
via Canturina Vecchia, 13
22070 Senna Comasco (CO), Italy
T. +39 0362 96991
F. +39 0362 969920
info@mandelli.it

mandelli.it

@mandelli1953

70 $\frac{M}{53/23}$