

MANDELLI 1953

Design
in your
hands

Ogni azienda nasce da un sogno e quello del fondatore di Mandelli Maniglie aveva il colore dell'oro: l'ottone. Correva l'anno 1953. Passione per la bellezza e ingegno che genera innovazione: il saper fare consiste in questo ed è un valore in cui MANDELLI1953 si riconosce da sempre.

Every business emerges from a dream and that of the founder of Mandelli Maniglie was a golden dream, and it was all about brass. That was back in 1953. The passion for beauty and the ingenuity that drives innovation is what creates expertise, something that has always been a defining feature of MANDELLI1953.

index

06	Mandelli 1953
20	Atelier
32	Archives
36	Designers
40	Finishes
48	Contemporary
152	Classic
184	Complements
204	Accessories
210	Technical Data
260	Overview

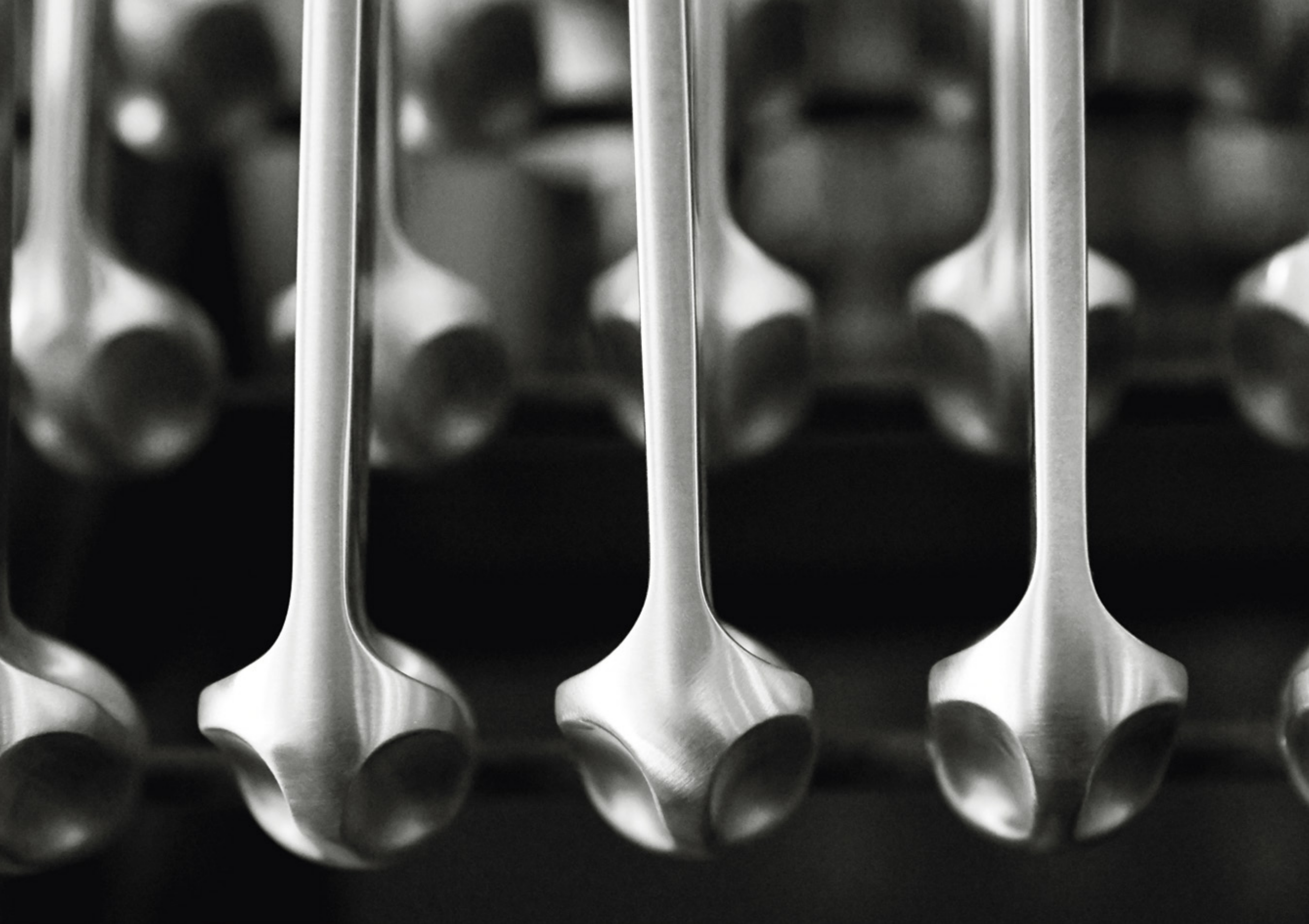

Mandelli1953

Da oltre sessant'anni progettiamo e realizziamo maniglie in ottone. Eccellente qualità, creatività e continua ricerca per un prodotto altamente affidabile di elevato valore estetico, interamente lavorato in Italia.

For over sixty years we have been designing and manufacturing brass handles. Excellent quality, creativity and continuous research for a highly reliable product of high aesthetic value, entirely processed in Italy.



Dalla scelta dell'ottone, italiano e di primissima qualità, fino all'imballaggio della maniglia finita, l'intera produzione viene seguita con la massima cura e dedizione in Italia, nel distretto della Brianza. Per questo MANDELLI1953 marca tutti i suoi prodotti con il logo "100% MADE IN ITALY". Quello che il marchio MANDELLI1953 esporta nel mondo non è solo un prodotto d'eccellenza ma un'intera cultura dell'oggetto realizzato ad arte, del saper fare italiano e dell'alta artigianalità, derivata da antiche tradizioni che negli anni hanno saputo rinnovarsi e utilizzare le migliori tecnologie.

From the choice of the brass, which is of the highest quality and wholly Italian, through to the packaging of the finished handles, the whole of the production process is characterised by great care and attention to detail, here in the Brianza district of Italy. MANDELLI1953 marks all its products "100% MADE IN ITALY". The brand that MANDELLI1953 exports is not only a mark of excellence, but represents all the culture, art and manufacturing ability that has emerged from its Italian traditions, heritage and craftsmanship, while always, through all these years, drawing on the finest technologies available.



Oltre sessant'anni di storia sono un patrimonio di sapienza artigianale prezioso, cui si aggiungono dedizione, abilità manuale e tecnologia industriale per spingere costantemente l'azienda a produrre nuovi modelli tecnologicamente all'avanguardia con finiture innovative e sostenibili. La continua attività di ricerca da parte del Centro Ricerca e Sviluppo è mirata a coniugare forma e funzione senza compromessi, ponendo MANDELLI1953 tra le aziende leader nel settore, su territorio nazionale e internazionale.

Over sixty years in the business have given the company great experience in the artisanal tradition, to which it has added dedication, manual skills and industrial technology which have together provided the impetus for a constant flow of technically highly advanced models with innovative and sustainable finishes. Constant work in the Research and Development department has sought out the best possible combinations of form and function, while never compromising on quality. All this has gone to make MANDELLI1953 one of the leading companies in the sector, both nationally and internationally.



La qualità per MANDELLI1953 si riferisce, prima ancora che alle indiscutibili caratteristiche tecnologiche dei suoi prodotti, a un insieme di atti, un misto di testardaggine, strategia della pazienza e passione per i dettagli. Tutte le maniglie vengono realizzate all'interno dell'azienda utilizzando unicamente ottone italiano certificato, cui viene data forma tramite forgiatura, tornitura e pressofusione, smerigliatura, vibratura, lucidatura e satinatura – trattamenti galvanici e trattamenti di metallizzazione (PVD) e verniciature. Inflessibile l'attenzione per il ben fatto: sono sempre i particolari a fare la differenza tra un buon prodotto e un manufatto di livello superiore, consapevolezza fondamentale dell'azienda.

For MANDELLI1953 quality means, even before the technology, a whole series of actions, stubbornness, a strategy of patience and a passion for detail. All our handles are made in our own factory using only certified Italian brass. This is forged, turned, die cast, ground, vibrated, polished and satin-finished on the premises, as well as being treated with galvanising, metalizing (PVD) and varnishing processes. The care taken over the quality of the finished product is unyieldingly constant, where it is the detail that makes the difference between a good product and an excellent one, something of which the company has always been very keenly aware.



MANDELLI 1953 ha ottenuto presso l'Istituto IFT Rosenheim, organismo che assicura un prestigioso riconoscimento a livello europeo, le seguenti certificazioni: EN 1906 : 2010: classificazione 47-0040B, una nuova certificazione europea che testa la durata e la resistenza all'usura e alla corrosione di maniglie e pomoli, collocando i prodotti nella fascia più alta (classe 4). EN 1670 : 2007: una certificazione che colloca i prodotti MANDELLI1953 in classe 4, la più alta classe di resistenza alla corrosione (240 ore in nebbia salina).

MANDELLI1953 obtained the following certificates at the IFT Rosenheim Institute, an institution that assures prestigious European recognition: EN 1906 : 2010: class 47-0040B, a new European certificate testing durability, static strength and corrosion resistance for lever handles and knobs, obtaining category of use class 4. EN 1670 : 2007: this certificate gives MANDELLI1953 the highest quality level (class 4) regarding resistance to corrosion (240 hours in salty fog chamber).

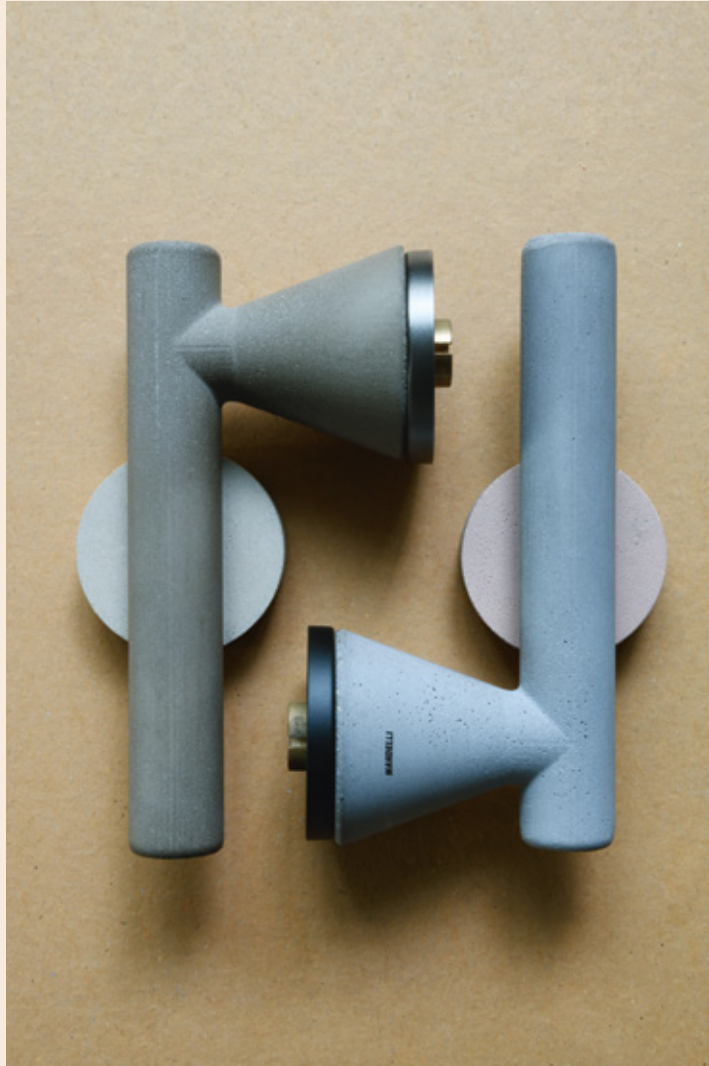

Premi. L'unione di abilità manuale e tecnologia industriale, la continua attività di ricerca mirata a coniugare forma e funzione, la collaborazione con importanti firme del panorama nazionale e internazionale: è questa la filosofia alla base di ogni progetto. Una produzione costante di nuovi modelli, sempre abbinati a finiture innovative e sostenibili, si è fatta notare, ricevendo negli anni prestigiosi riconoscimenti.

Awards. The creative mix of manual skill and industrial technology, the non stopping research aimed to combine form and function, the collaboration with important designers from both the national and the international panorama: these are the ingredients behind each MANDELLI1953 project. A philosophy on which relies a constant production of new models, always combined with innovative finishes and sustainable, it has been noted, receiving prestigious awards over the years.



Sono i dettagli che danno valore a porte e finestre, rivelando il carattere degli spazi che arredano: nasce Atelier Mandelli, dove la cura di un laboratorio artigianale e le risorse di una produzione industriale in continuo aggiornamento si uniscono per soddisfare ogni richiesta progettuale, sia in termini funzionali che estetici.

atelier

All that is special in doors and windows is to be found in the detail, as it reflects the character of the space they embellish. Atelier Mandelli came into being to bring together the care and attention of an artisanal workshop and the resources of a constantly updated manufacturing processes designed to meet the needs of any project, both in terms of function and aesthetic design.

atelier

Juno, Contemporary Collection
Sand

Cemento. Ricerca e sperimentazione ispirano il progetto Juno firmato Alessandro Dubini per MANDELLI1953. Il materiale costruttivo è il cemento, duro e al tempo stesso morbido, quasi vellutato al tatto. Colori ispirati alle sfumature della terra. Una forma contemporanea ed essenziale per esaltare l'originale scelta del materiale, protagonista incontrastato di questo progetto. Vincitrice del premio Good Design 2017.

Concrete. Research and experiment inspire the Juno project of Alessandro Dubini for MANDELLI1953. The construction material used is concrete, which is hard and yet soft, almost velvet to the touch. Colours are inspired by earthy hues, while contemporary and clean forms emphasise the originality and unquestioned leading role of the chosen material. Good Design Winner 2017.



atelier

Kuki, Contemporary Collection
Oro Lucido / Polished brass

Madreperla. Lucentezza e iridescenza fanno della materia stessa la protagonista di questa personalizzazione. Un innesto dalle svariate sfumature e colorazioni rende ogni maniglia ancora più preziosa.

Motherpearl. Shine and iridescence make the finish the protagonist of this customization. A graft of various shades and colors makes each handle even more precious.

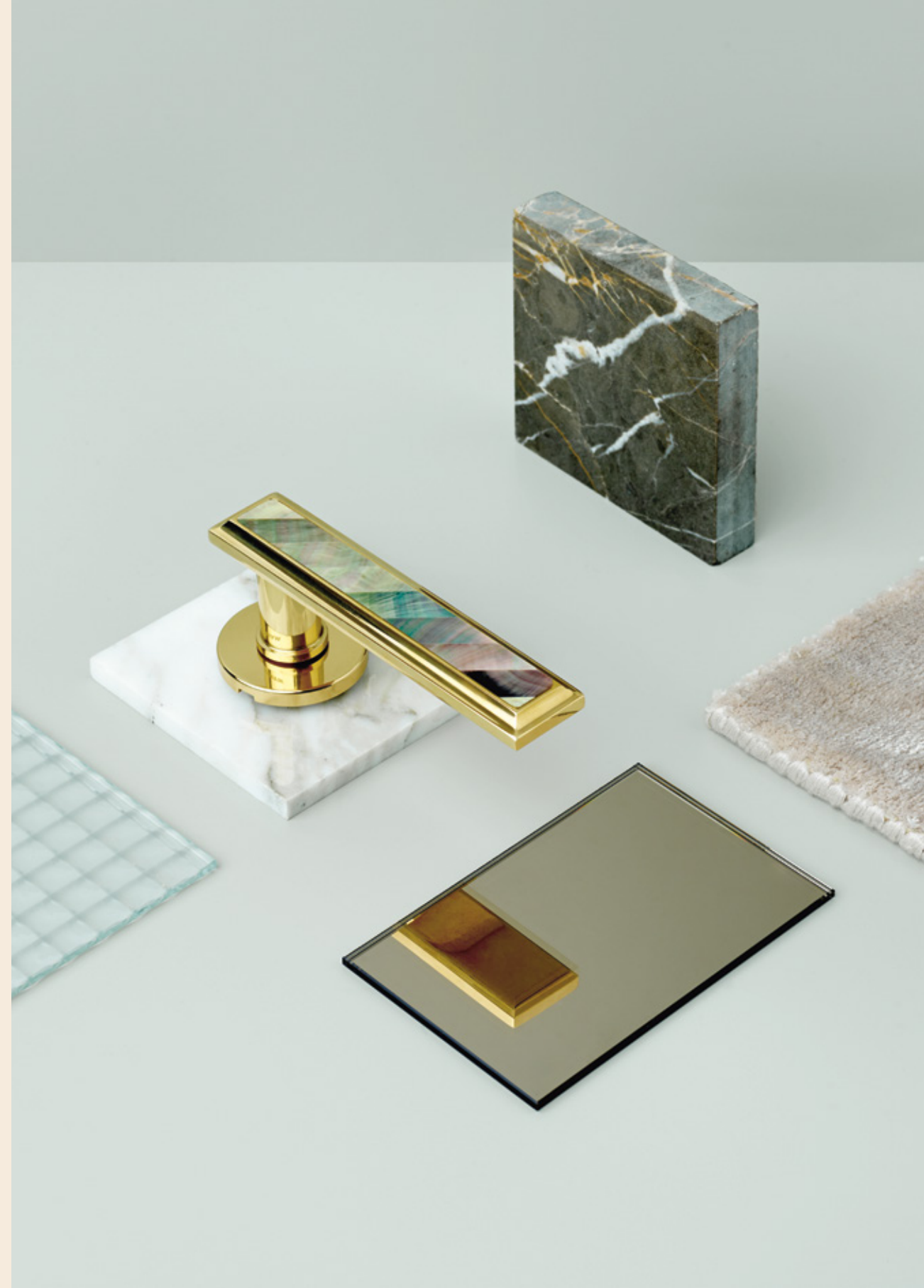

Ola, Contemporary Collection
Oro Lucido / Polished brass

Incisa. Il punto di incontro tra ornamento e design. È la possibilità di ottenere decorazioni precise sulla superficie metallica di base, l'ottone, da cui prendono forma le maniglie MANDELLI1953. La tecnica Guilloche, realizzata da un'apposita macchina guidata manualmente, genera un preciso pattern, dove il fascino dell'artigianato e l'avanguardia tecnologica si uniscono per generare infiniti disegni.

Engraving. Where ornament and design meet. Detailed decoration on the brass of the MANDELLI1953 handles is achieved by the use of such techniques as guilloche, using a manually guided machine. The resulting patterns reflect both the artisan tradition and the employment of state of the art technology in an infinite array of designs.



atelier

Bilbao, Contemporary Collection
Cromo lucido / Polished chrome
Pelle grigio scuro / Dark grey leather

Pelle Dettaglio morbido e raffinato, per avvolgere i progetti MANDELLI1953. La pelle non poteva mancare in un Atelier, materiale ideale per essere cucito intorno ad ogni singola idea. Lavorato a mano, con esperienza artigiana e una visione ispirata alle più moderne decorazioni di interni.

Leather soft and refined detail, to wrap the MANDELLI1953's projects. The leather could not missing in an Atelier, the ideal material to be sewn around every single idea. Hand made, with artisan experience and a vision inspired by the most modern interior decorations.



atelier

Naxos, Classic Collection

Cromo lucido / Polished chrome

Marmo Nero Marquinia / Marble Black Marquinia

Marmo. Tocco di classe sempre attuale nella decorazione d'interni, il marmo, è la proposta ideale per impreziosire i pezzi senza tempo della collezione MANDELLI1953. Fulcro di progetti realizzati ad hoc, suggeriti dall'eleganza e dalle proprietà uniche del Marquinia o del Calacatta. Made in Italy, come nella nostra filosofia.

Marble. Marble provides that perennial touch of class to interiors. It is the ideal embellishment for timeless items in the MANDELLI1953 collection. It is the fulcrum of ad hoc projects suggested by the elegance and uniqueness of Marquinia and of Calacatta. Rigorously made in Italy, and entirely in line with our philosophy.



La collezione Archivi di MANDELLI1953 è una ricerca tra architetti, designer e artisti del passato, precursori di stili e forme proiettate verso il futuro. Una raccolta di riedizioni e di progetti inediti scoperti negli archivi e proposti per la prima volta al grande pubblico. Un omaggio a tutta la creatività Made in Italy e una fonte di ispirazione per le nuove generazioni.

archives

The MANDELLI1953 Archives collection is a search for architects, designers and artists of the past, precursors of styles and forms projected towards the future. A collection of re-editions and unpublished projects discovered in the archives and proposed for the first time to the general public. A tribute to all the Made in Italy creativity and a source of inspiration for the new generations.



MM80 è il secondo modello della sezione Archivi di Mandelli 1953. Disegnata da Marcello Morandini (architetto, artista, designer) nei toni netti del nero e del bianco, in armonia tra i pieni e i vuoti, è una scultura da impugnare.

MM80 is the second model in the Archives section of Mandelli 1953. Designed by Marcello Morandini (architect, artist, designer), born in black and white, made of harmony between solids and voids, is a sculpture to be held.



reddot winner 2021



PP33 è il nome scelto per la riedizione esclusiva di una maniglia realizzata nel 1933 dal noto architetto Piero Portaluppi. Il nuovo progetto rappresenta il primo modello di maniglia parte del progetto Archivi.

PP33 is the exclusive re-edition of a handle made in 1933 by the well-known architect Piero Portaluppi. The new project represents the first handle model part of the Archives project.



designers

MANDELLI1953 comprende visioni e creazioni di una selezione di autori scelti per collaborare e costruire un dialogo continuo con il mondo del design e del progetto, affinché designer contemporanei uniscano le loro maniglie ai preziosi classici ed ai modelli iconici del marchio.

MANDELLI1953 comprises the vision and creativity of a team meant to cooperate on an ongoing dialogue with the world of design, where the creative minds of today bring together the contemporary and the best of classic models in the brand's back catalogue.



Pier Francesco
Arnone



Dodo
Arslan



Giuseppe
Bavuso



Piet
Billekens



Massimo
Cavana



Studio WA+CH
Wei Chin Cjien



Alessandro
Dubini



Marcello
Morandini

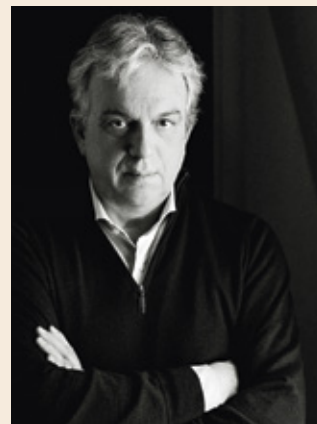

Marco
Piva

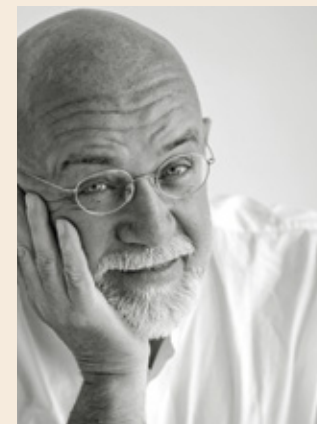

Franco
Poli



Piero
Portaluppi



L Ponzelli
F Valentini

finishes

L'eleganza dell'oro o la moderna brillantezza del cromo. Effetti antichizzati o raffinate satinature. Ciascun prodotto è in duro e resistente ottone, mentre un ventaglio di finiture permette poi a ciascuno di scegliere la maniglia più adatta al proprio stile.

The elegance of gold and the modernist brilliance of chrome. Antique looks or sophisticated satin finishes. Every product is made of hard and resilient brass, while a whole bouquet of finishes means everyone can find the handle that best suits their own style.





Fluxcoating Vitrified. Si può migliorare un materiale già eccellente? Il Centro Ricerca e Sviluppo MANDELLI1953 ne è convinto; ecco perché è stato messo a punto il sistema FLUXCOATING VITRIFIED, un rivestimento capace di migliorare le qualità estetiche dell'ottone e di mantenerle inalterate nel tempo. Il processo consiste in una serie di interventi preparatori del prodotto e nel successivo rivestimento con speciali resine. Il risultato è un'impareggiabile resistenza agli agenti atmosferici, agli urti ed alle abrasioni. Il trattamento FLUXCOATING è applicato alle speciali ed esclusive finiture di Mandelli 1953: MBR (brunito opaco), MSN (nickel satinato opaco), AB (brunito antico), 28 (argento vecchio).

Fluxcoating Vitrified. Can an already excellent material be improved upon? The research department of MANDELLI1953 is sure that it can; which is why it has developed its VITRIFIED FLUXCOATING system, a protective coating that enhances the appearance of the brass while ensuring it has a long life. The product goes through a series of preliminary processes, followed by the application of coatings with special resins. The result is excellent resistance to weathering, shock and abrasion, while the natural shine of the polished brass remains unchanged. The FLUXCOATING treatment is available for the following finishes: MBR (mat bronze), MSN (mat satin nickel), AB (antique bronze), 28 (antique chrome).



PVD. Un ulteriore trattamento applicabile ai prodotti MANDELLI1953 è il rivestimento PVD che presenta ottimi risultati di resistenza all'abrasione, alla corrosione e tenuta del colore nel tempo, anche in ambienti esterni e pubblici. Elevate sono le caratteristiche tecniche:

- resistenza al test di stabilità alla luce solare UNI 9337 senza alcuna variazione oltre le 1000 ore;
- ottimi risultati in nebbia salina secondo le norme UNI ISO 9227 di resistenza al CASS e al AASS;
- elevata durezza superficiale ASTM B578-93 di 2600 ÷ 2800 HV (un normale riporto di cromo galvanico ha durezza 800 HV);
- perfetta aderenza al pezzo superando il test UNI ISO 4524-5;
- resistenza ad acidi e alcali come acido cloridrico, solforico, cianuri ecc.

Il trattamento PVD è disponibile per i modelli contrassegnati dal simbolo dedicato, solo sulle versioni rosetta/bocchetta e DK.

Physical Vapor Deposition. An additional treatment applied to some MANDELLI 1953 products is PVD, which renders them highly resistant to abrasion, corrosion and bleaching, as well as making them suitable for outdoor and public places. The treatment achieves truly remarkable results:

- the bleaching resistance test shows no alteration even after a 1000 hour test, according to UNI 9337 norms;
- high performances for the resistance test to CASS and AAS according to UNI ISO 9227 norms in salty fog chamber;
- very high surface hardness according to ASTM B578-93 norms of 2600 ÷ 2800 HV (standard chrome plated product shows an 800 HV value);
- perfect adhesion, exceeding UNI ISO 4524-5 norms;
- resistance to acids and alkalis (hydrochloric, sulphuric, cyanide etc...).

The treatment is available on models bearing the PVD symbol, that is to say for the rose/escutcheon version, and with the GOLD and CHROME INOX finishes.

galvaniche galvanic



24KT
ORO 24KT
24KT GOLD



MSN
NICKEL SATINATO OPACO
MAT SATIN NICKEL



PB|BR
BRUNITO
BRONZE



IB
BRONZO SCULTURA
IMPERIAL BRONZE



BP
NERO PERLA
BLACK PAERL

PVD



PVD
INOX LUCIDO
POLISHED INOX

finishes



03
ORO
POLISHED BRASS



RG
ORO ROSA
ROSE GOLD



26
CROMO LUCIDO
POLISHED CHROME



MBR
BRUNITO OPACO
MAT BRONZE



28
ARGENTO VECCHIO
ANTIQUE CHROME



MB
NERO OPACO
MAT BLACK



PVD
ORO LUCIDO
POLISHED BRASS

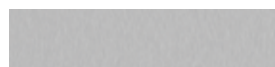

PVD
INOX SATINATO
SATIN INOX



04
ORO SATINATO
SATIN BRASS



NL
NICKEL LUCIDO
POLISHED NICKEL



26D
CROMO SATINATO
SATIN CHROME



AB
BRUNITO ANTICO
ANTIQUE BRONZE



15A
GRAFITE
GRAPHITE



MW
BIANCO OPACO
MAT WHITE



PVD
ORO SATINATO
SATIN BRASS

finishes



CIPRIA
BLUSH



CENERE
ASH



60
MARRONE SCURO
DARK BROWN



42
GRIGIO SCURO
DARK GREY



NERO MARQUINA
BLACK MARQUINA

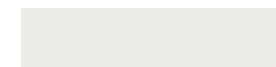

CERAMICA BIANCA
WHITE CERAMIC

cemento concrete



TORTORA
DOVE

pelle leather



15
CUOIO NATURALE
NATURAL LEATHER

marmo marble

ceramica ceramic



GRAFITE
GRAPHITE



SABBIA
SAND



49
TORTORA
DOVE



BIANCO CALACATTA
WHITE CALACATTA
VAGLI ORO

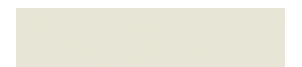

CERAMICA AVORIO
IVORY CERAMIC

contemporary collection

Una collezione di maniglie progettate per essere interpreti dello stile e del design più moderno: un irresistibile mix di stupefacente creatività e rigore funzionale.

A collection of handles designed to be interpreted in the spirit of the most modern trends in furnishing styles, in an irresistible mix of amazing creativity and functional rigour.

contemporary collection

● 451	ande	56	● 1091	led	104
● 1791	aqualung	58	● 1131	mitos	110
● 3191	ara	60	● 080	MM80	112
● 307	aries	62	● 771	nadir	114
● 1671	bilbao	66	● 1071	ola	118
● 1141	bix	68	● 033	PP33	122
● 1611	callas	70	● 591	special	126
● 1181	chio	74	● 731	spin	128
● 3181	demì	76	● 5101	start	130
● 721	filo	82	● 461	totem	134
● 1731	fusilla	86	● 361	tuc	136
● 1751	grint	88	● 1301	zante	142
● 1081	isi	90	● 711	zen	146
● 8021	juno	94	● 381	zoe	148
● 1741	kuki	100	● 351	zoom	150

contemporary collection

■	1831	40+1	54
■	1631	astrid	64
■	1621	carré	72
■	1291	fan	78
■	1601	fenix	80
■	1871	frame	84
■	1371	jet	92
■	1950	K	96
■	1461	kiri	98
■	1681	lario	102
■	1171	life	106
■	1031	link	108
■	1501	nuria	116
■	1251	piramid	120
■	1761	seven	124
■	1161	telis	132
■	1691	twee	138
■	1651	virgo	140
■	1721	zeit	144

40+1

design Lorenzo Ponzelli e Francesco Valentini



26D Cromo satinato
Polished chrome



15A Grafite
Graphite



MSN Nickel satinato opaco
Mat satin nickel



NL Nickel lucido
Polished nickel



PB Nero perla
Black pearl

collezione / collection

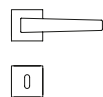

1831 con rosetta
on rose



1832/DK martellina
drehkipp system



ande



03 Oro lucido
Polished brass



04 Oro satinato
Satin brass



26 Cromo lucido
Polished chrome



26D Cromo satinato
Satin chrome



PB/BR Brunito
Bronze



MBR Brunito opaco
Mat bronze

collezione / collection

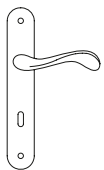

450 con piastra
on back plate

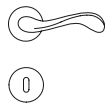

451 con rosetta
on rose



452/M cremonese
window lever-handle



452/DK martellina
drehkipp system

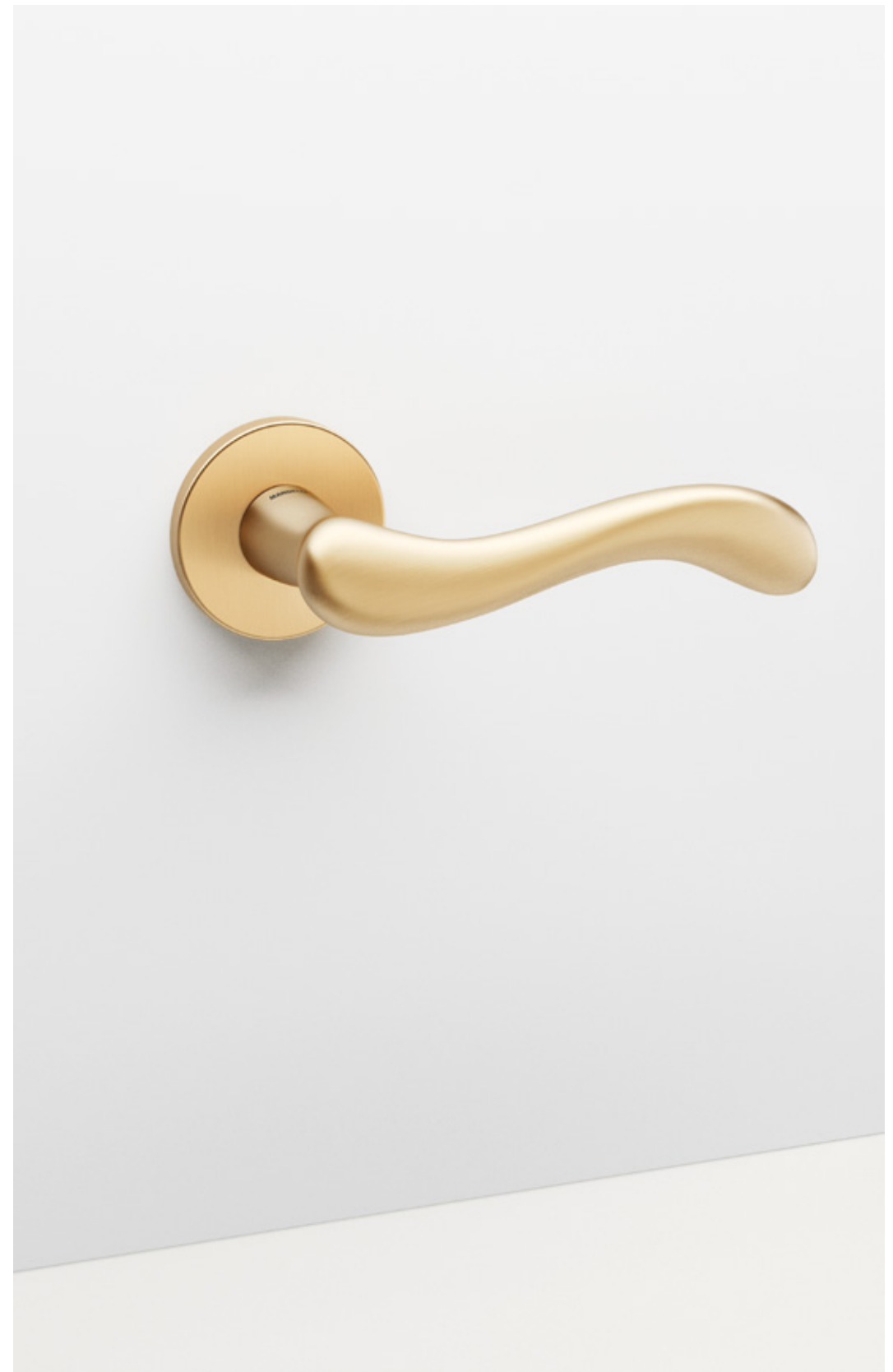

aqualung

design Franco Poli



03 Oro lucido
Polished brass



04/03 Oro satinato/lucido
Satin/ Polished brass



26 Cromo lucido
Polished chrome



26D/26 Cromo satinato/lucido
Satin/ Polished chrome



15A Grafite
Graphite



MSN Nickel satinato opaco
Mat satin nickel

collezione / collection

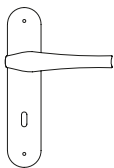

1790 con piastra
on back plate

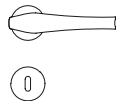

1791 con rosetta
on rose



1792/M cremonese
window lever-handle



1792/DK martellina
drehkipp system



ara



04/03 Oro satinato/lucido
Satin brass / Polished brass



26D /26 Cromo satinato/lucido
Satin chrome / Polished chrome



MSN Nickel satinato opaco
Mat satin nickel



MBR Brunito opaco
Mat bronze

collezione / collection

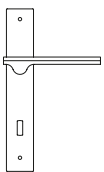

3190 con piastra
on back plate

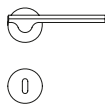

3191 con rosetta
on rose



3192/M cremonese
window lever-handle



3192/DK martellina
drehkipp system

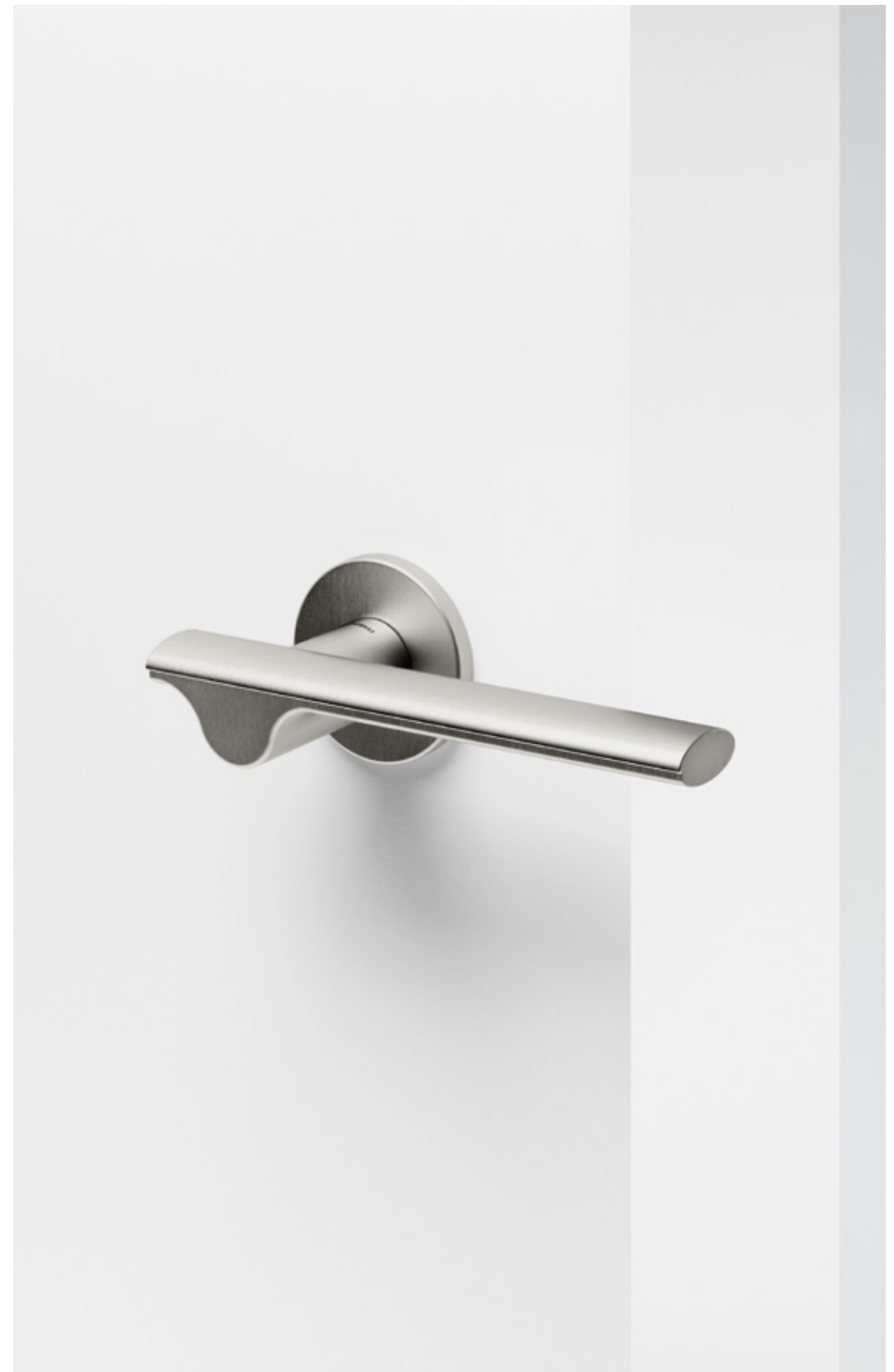

aries

design Giuseppe Bavuso



04 Oro satinato
Satin brass



26D Cromo satinato
Satin chrome



MSN Nickel satinato opaco
Mat satin nickel



15A Grafite
Graphite



MB Nero opaco
Black mat

collezione / collection

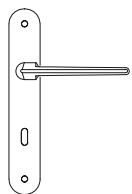

1940 con piastra
on backplates

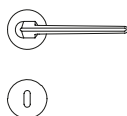

1941 con rosetta
on rose



1942/DK martellina
drehkipp system



astrid



03 Oro lucido
Polished brass



04 Oro satinato
Satin brass



26 Cromo lucido
Polished chrome



26D Cromo satinato
Satin chrome



MSN Nickel satinato opaco
Mat satin nickel



15A Grafite
Graphite

collezione / collection

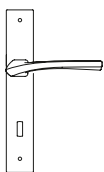

1630 con piastra
on back plate

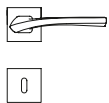

1631 con rosetta
on rose



1632/M cremonese
window lever-handle



1632/DK martellina
drehkipp system



bilbao



03 Oro lucido
Polished brass



04 Oro satinato
Satin brass



03/04 Oro lucido/satinato
Polished/Saten brass



26/26D Cromo lucido/satinato
Polished/Satin chrome



26 Cromo lucido
Polished chrome



26D Cromo satinato
Polished chrome

Disponibile nella versione Incisa e Pelle
Available in its Incisa and Leather version

collezione / collection

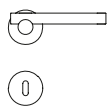

1671 con rosetta
on rose

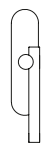

1672/M cremonese
window lever-handle



1672/DK martellina
drehkip system

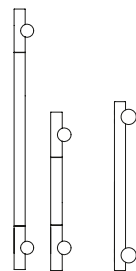

1675 | 1675S maniglione
pull handle



bix



04/03 Oro satinato/lucido
Satin/Polished brass



26D/26 Cromo satinato/lucido
Satin/Polished chrome



MB/26 Nero opaco/cromo
Mat black/Chrome

collezione / collection

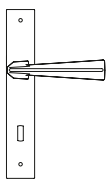

1140 con piastra
on back plate

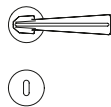

1141 con rosetta
on rose



1142/M cremonese
window lever-handle



1142/DK martellina
drehkipp system



callas

design Piet Billekens



03 Oro lucido
Polished brass



04 Oro satinato
Satin brass



26 Cromo lucido
Polished chrome



26D Cromo satinato
Satin chrome



1B Bronzo scultura
Imperial bronze



BP Nero perla
Pearl black



15A Grafite
Graphite

collezione / collection

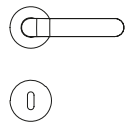

1611 con rosetta
on rose



1612/M cremonese
window lever-handle



1612/DK martellina
drehkipp system

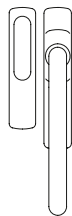

196/A maniglione alzante
pull up



carré

design Piet Billekens



03 Oro lucido
Polished brass



04 Oro satinato
Satin brass



26 Cromo lucido
Polished chrome



26D Cromo satinato
Satin chrome

collezione / collection



1620 con rosetta
on rose



chio



03/04 Oro lucido/satinato
Polished/Saten brass



26/26D Cromo lucido/satinato
Polished/Satin chrome



collezione / collection

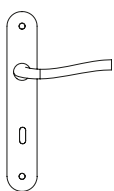

1180 con piastra
on back plate

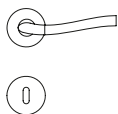

1181 con rosetta
on rose



1182/M cremonese
window lever-handle



1182/DK martellina
drehkipp system

demì



26/AW Cromo lucido/Bianco
Polished chrome/White



collezione / collection

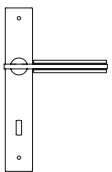

3810 con piastra
on back plate

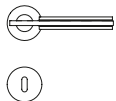

1261 con rosetta
on rose

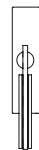

1262/M cremonese
window lever-handle



1262/DK martellina
drehkipp system

fan



04 Oro satinato
Satin brass



IB Bronzo scultura
Imperial bronze



26 Cromo lucido
Polished chrome



26D Cromo satinato
Satin chrome



MSN Nickel satinato opaco
Mat satin nickel

collezione / collection

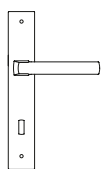

1290 con piastra
on back plate

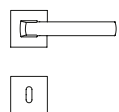

1291 con rosetta
on rose



1292/M cremonese
window lever-handle



1292/DK martellina
drehkipp system



fenix

design Piet Billekens



03 Oro lucido
Polished brass



04 Oro satinato
Satin brass



26 Cromo lucido
Polished chrome



26D Cromo satinato
Satin chrome



MSN Nickel satinato opaco
Mat satin nickel

collezione / collection

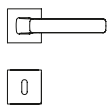

1601 con rosetta
on rose

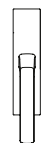

1602/M cremonese
window lever-handle



1602/DK martellina
drehkipp system



filo



04/03 Oro satinato/lucido
Satin/polished brass



MBR Brunito opaco
Mat bronze



26D/26 Cromo satinato/lucido
Satin /Polished chrome



MSN Nickel satinato opaco
Mat satin nickel

collezione / collection

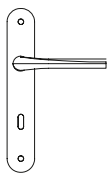

720 con piastra
on back plate

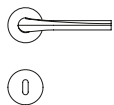

721 con rosetta
on rose



722/M cremonese
window lever-handle



722/DK martellina
drehkipp system



frame

design WA+CH



04/03 Oro satinato/lucido
Satin/polished brass



RGS/RG Oro rosa satinato/lucido
Saten/polished brass rose gold



26D/26 Cromo satinato/lucido
Satin /Polished chrome



MB Nero opaco
Black mat

collezione / collection

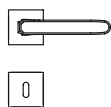

1871 con rosetta
on rose



1872/DK martellina
drehkipp system



fusilla

design Alessandro Dubini



03 Oro lucido
Polished brass



MBR Brunito opaco
Mat bronze



26 Cromo lucido
Polished chrome



15A Grafite
Graphite

collezione / collection

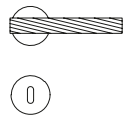

1731 con rosetta
on rose

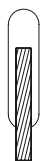

1732/M cremonese
window lever-handle



1732/DK martellina
drehkipp system



1735 | 1735S maniglione
pull handle



grint



04 Oro satinato
Satin brass



MBR Brunito opaco
Mat bronze



26 Cromo lucido
Polished chrome



26D Cromo satinato
Satin chrome



MSN Nickel satinato opaco
Mat satin nickel



15A Grafite
Graphite



Incisa
Engraved



K Godronata
Knurled

collezione / collection

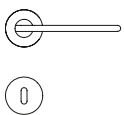

1751 con rosetta
on rose



722/M cremonese
window lever-handle



722/DK martellina
drehkipp system



isi



04 Oro satinato
Satin brass



MSN Nickel satinato opaco
Mat satin nickel



26 Cromo lucido
Polished chrome



26D Cromo satinato
Satin chrome



collezione / collection

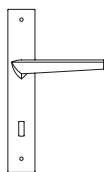

1080 con piastra
on back plate

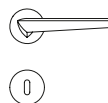

1081 con rosetta
on rose

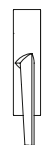

1082/M cremonese
window lever-handle



1082/DK martellina
drehkipp system

jet



04 Oro satinato
Satin brass



MB Nero opaco
Black mat



26 Cromo lucido
Polished chrome



26D Cromo satinato
Satin chrome



collezione / collection

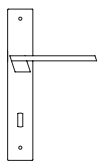

1370 con piastra
on back plate

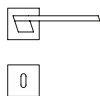

1371 con rosetta
on rose



1372/M cremonese
window lever-handle



1372/DK martellina
drehkipp system

juno

design Alessandro Dubini



Cenere
Ash



Grafite
Graphite



Sabbia
Sand



Tortora
Dove



Cipria
Blush

collezione / collection

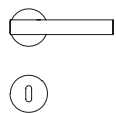

1371 con rosetta
on rose



1372/DK martellina
drehkipp system



K

design Alessandro Dubini



03 Oro lucido
Polished brass



04 Oro satinato
Satin brass



26 Cromo lucido
Polished chrome



26D Cromo satinato
Satin chrome



MB Nero opaco
Mat black



MW Bianco opaco
Mat white

collezione / collection



1950



kiri



03 Oro lucido
Polished brass



04 Oro satinato
Satin brass



26 Cromo lucido
Polished chrome



26D Cromo satinato
Satin chrome



MSN Nickel satinato opaco
Mat satin nickel



MBR Brunito opaco
Mat bronze

collezione / collection

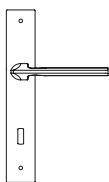

1460 con piastra
on back plate

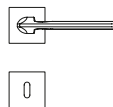

1461 con rosetta
on rose

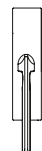

1462/M cremonese
window lever-handle



1462/DK martellina
drehkipp system



kuki



03 Oro lucido
Polished brass



03/04 Oro lucido/satinato
Polished/Saten brass



26 Cromo lucido
Polished chrome



26/26D Cromo lucido/satinato
Polished/Satin chrome



MBR Brunito opaco
Mat bronze



15A Grafite
Graphite

Disponibile nella versione Incisa
Available in its Incisa version

collezione / collection

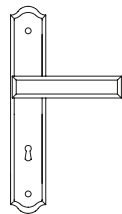

1740 con piastra
on back plate

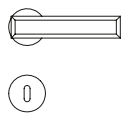

1741 con rosetta
on rose



1742/M cremonese
window lever-handle



1742/DK martellina
drehkipp system



lario



03 Oro lucido
Polished brass



MSN Nickel satinato opaco
Mat satin nickel



26 Cromo lucido
Polished chrome



26D Cromo satinato
Satin chrome



collezione / collection

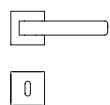

1681 con rosetta
on rose



1682/M cremonese
window lever-handle



1682/DK martellina
drehkipp system

led



03 Oro lucido
Polished brass



MSN Nickel satinato opaco
Mat satin nickel



26 Cromo lucido
Polished chrome



26D Cromo satinato
Satin chrome

collezione / collection

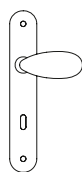

1090 con piastra
on back plate

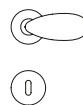

1091 con rosetta
on rose

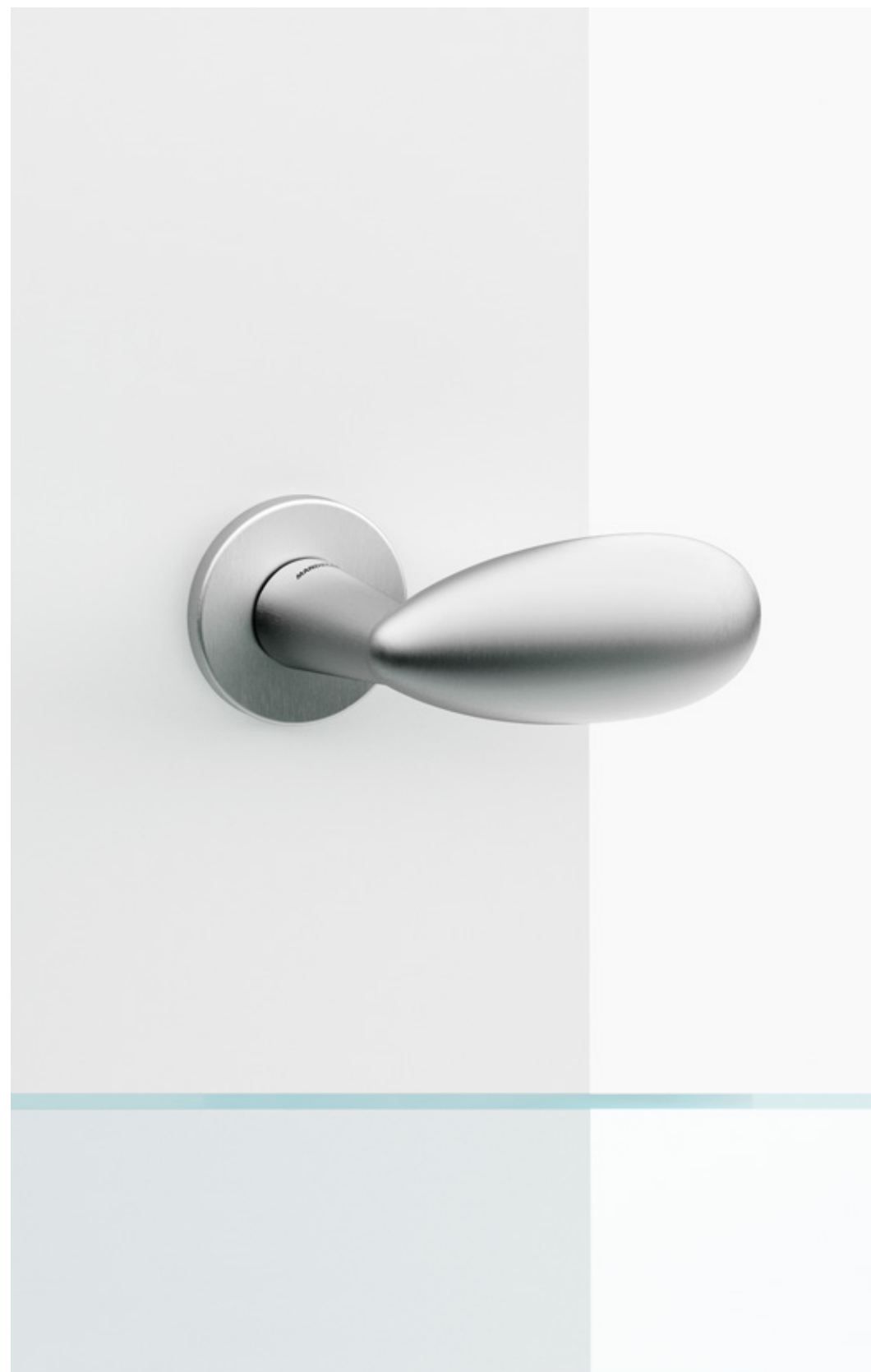

life



03/04 Oro lucido/satinato
Polished/Saten brass



26/26D Cromo lucido/satinato
Polished/Satin chrome



15A Grafite
Graphite



collezione / collection

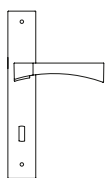

1170 con piastra
on back plate

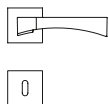

1171 con rosetta
on rose

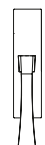

1172/M cremonese
window lever-handle



1172/DK martellina
drehkipp system



197/A alzante
pull up

link



03 Oro lucido
Polished brass



04 Oro satinato
Satin brass



26 Cromo lucido
Polished chrome



26D Cromo satinato
Satin chrome



MSN Nickel satinato opaco
Mat satin nickel



MBR Brunito opaco
Mat bronze

collezione / collection

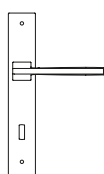

1030 con piastra
on back plate

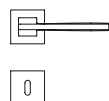

1030 con piastra
on back plate



1032/M cremonese
window lever-handle



1032/DK martellina
drehkipp system



1035 maniglione
pull handle



mitos



03 Oro lucido
Polished brass



04 Oro satinato
Satin brass



26 Cromo lucido
Polished chrome



26D Cromo satinato
Satin chrome



MSN Nickel satinato opaco
Mat satin nickel

collezione / collection

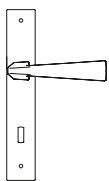

1130 con piastra
on back plate

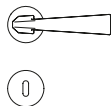

1131 con rosetta
on rose

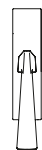

1132/M cremonese
window lever-handle



1132/DK martellina
drehkipp system

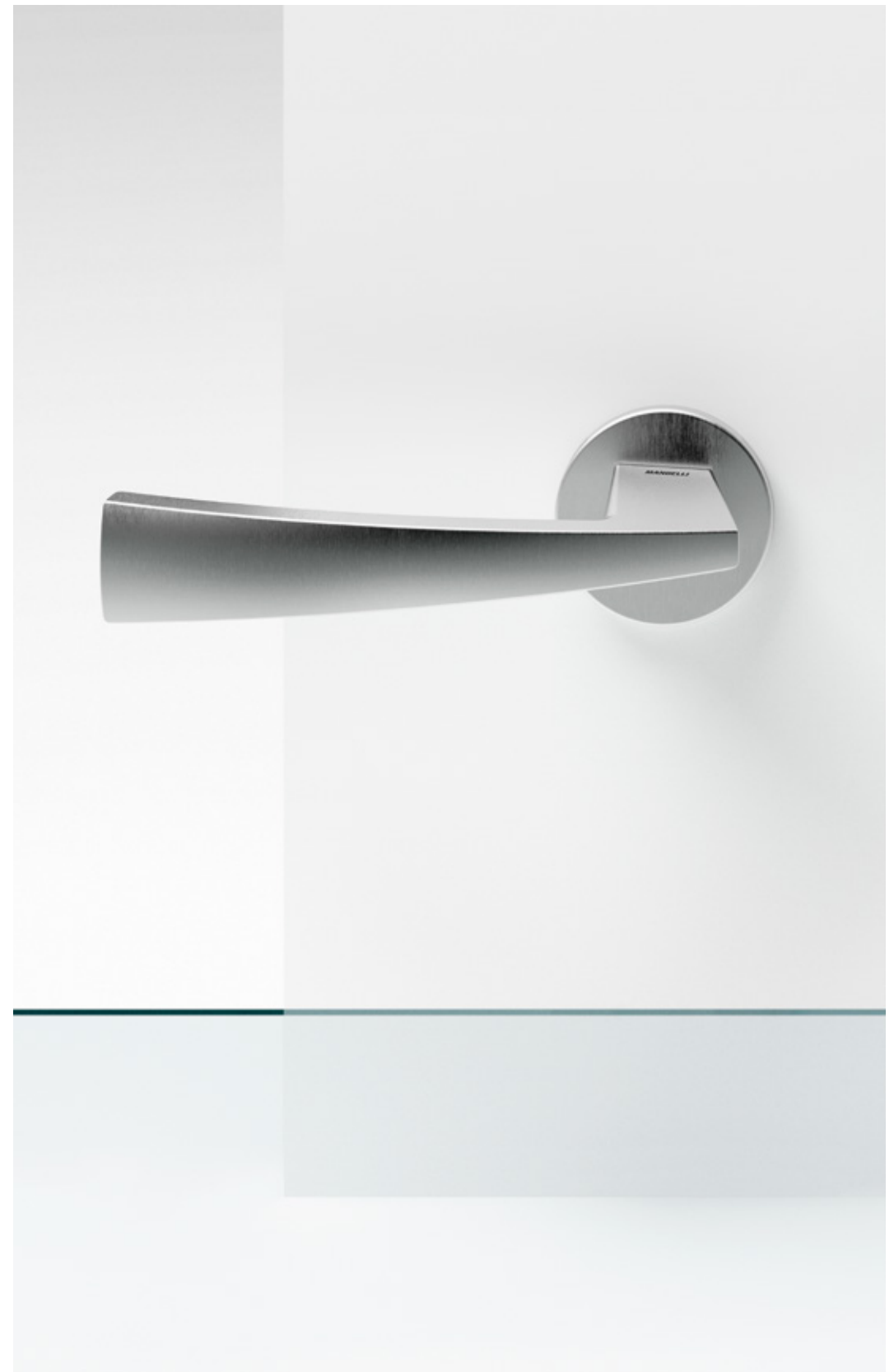

MM80

design Marcello Morandini

RED DOT
AWARDS
2021



MW/MB Bianco-Nero
White-Black



MB/BI Nero-Bianco
Black-White



MW Bianco opaco
Mat white



MB Nero opaco
Mat black



26 Cromo lucido
Polished chrome



26D Cromo satinato
Satin chrome



MSN Nickel satinato opaco
Mat satin nickel

collezione / collection

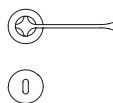

1921 con rosetta
on rose



1922/DK martellina
drehkipp system



nadir



03 Oro lucido
Polished brass



04 Oro satinato
Satin brass



26 Cromo lucido
Polished chrome



26D Cromo satinato
Satin chrome



BP Nero Perla
Black Paerl

collezione / collection

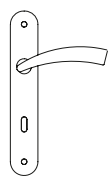

770 con piastra
on back plate

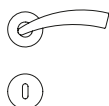

771 con rosetta
on rose



772/M cremonese
window lever-handle



772/DK martellina
drehkipp system



775 maniglione
pull handle



nuria



04 Oro satinato
Satin brass



15A Grafite
Graphite



26D Cromo satinato
Satin chrome



MSN Nickel satinato opaco
Mat satin nickel

collezione / collection

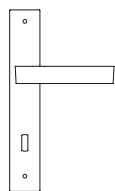

1500 con piastra
on back plate

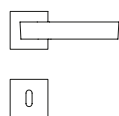

1501 con rosetta
on rose



1502/M cremonese
window lever-handle



1502/DK martellina
drehkipp system



ola



03 Oro lucido
Polished brass



04 Oro satinato
Satin brass



26 Cromo lucido
Polished chrome



26D Cromo satinato
Satin chrome



MSN Nickel satinato opaco
Mat satin nickel

Disponibile nella versione Incisa
Available in its Incisa version

collezione / collection

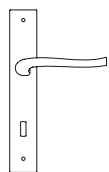

1070 con piastra
on back plate

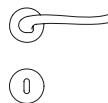

1071 con rosetta
on rose



1072/M cremonese
window lever-handle



1072/DK martellina
drehkipp system



piramid



26D Cromo satinato
Satin chrome



15A Grafite
Graphite



MSN Nickel satinato opaco
Mat satin nickel



collezione / collection

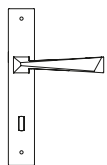

1250 con piastra
on back plat

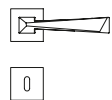

1251 con rosetta
on rose



1252/M cremonese
window lever-handle



1252/DK martellina
drehkipp system



1255 maniglione
pull handle

PP33

design Piero Portaluppi



03 Oro lucido
Polished brass



RG Oro rosa lucido
Polished rose gold



26 Cromo lucido
Polished chrome



NL Nickel lucido
Polished nickel



IB Bronzo scultura
Imperial bronze



MB Nero opaco
Mat black

collezione / collection

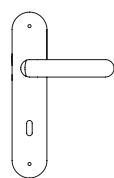

1800 con piastra
on back plate

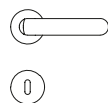

1801 con rosetta
on rose



1802/M cremonese
window lever-handle



1802/DK martellina
drehkipp system

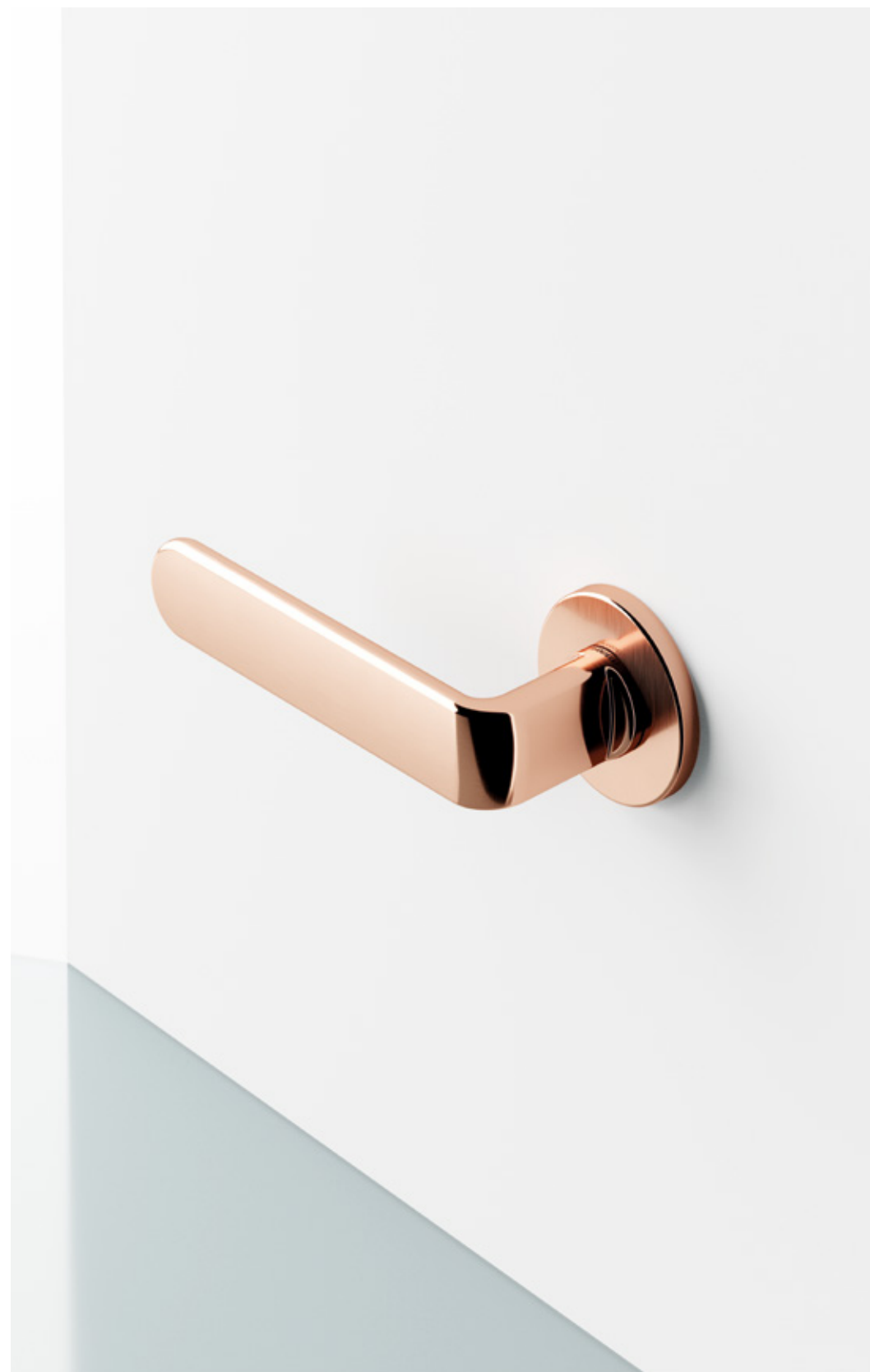

seven

design Marco Piva



03/04 Oro lucido/satinato
Polished/Satin brass



26/26D Cromo lucido/satinato
Polished/Satin chrome



MBR Brunito opaco
Mat bronze



15A Grafite
Graphite



BP Nero Perla
Black Paerl

collezione / collection

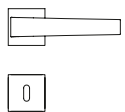

1761 con rosetta
on rose



1762/M cremonese
window lever-handle



1762/DK martellina
drehkipp system



special



03/04 Oro lucido/satinato
Polished/Saten brass



26/26D Cromo lucido/satinato
Polished/Satin chrome



MBR Brunito opaco
Mat bronze

collezione / collection

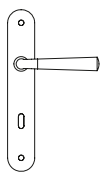

S90 con piastra
on back plate

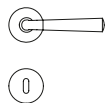

S91 con rosetta
on rose



S92/M cremonese
window lever-handle

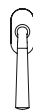

S92/DK martellina
drehkipp system



spin



04 Oro satinato
Satin brass



MSN Nickel satinato opaco
Mat satin nickel



26 Cromo lucido
Polished chrome



26D Cromo satinato
Satin chrome



MBR Brunito opaco
Mat bronze



IB Bronzo scultura
Imperial bronze

collezione / collection

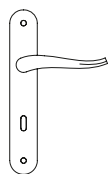

730 con piastra
on back plate

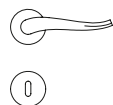

731 con rosetta
on rose



732/M cremonese
window lever-handle



732/DK martellina
drehkipp system

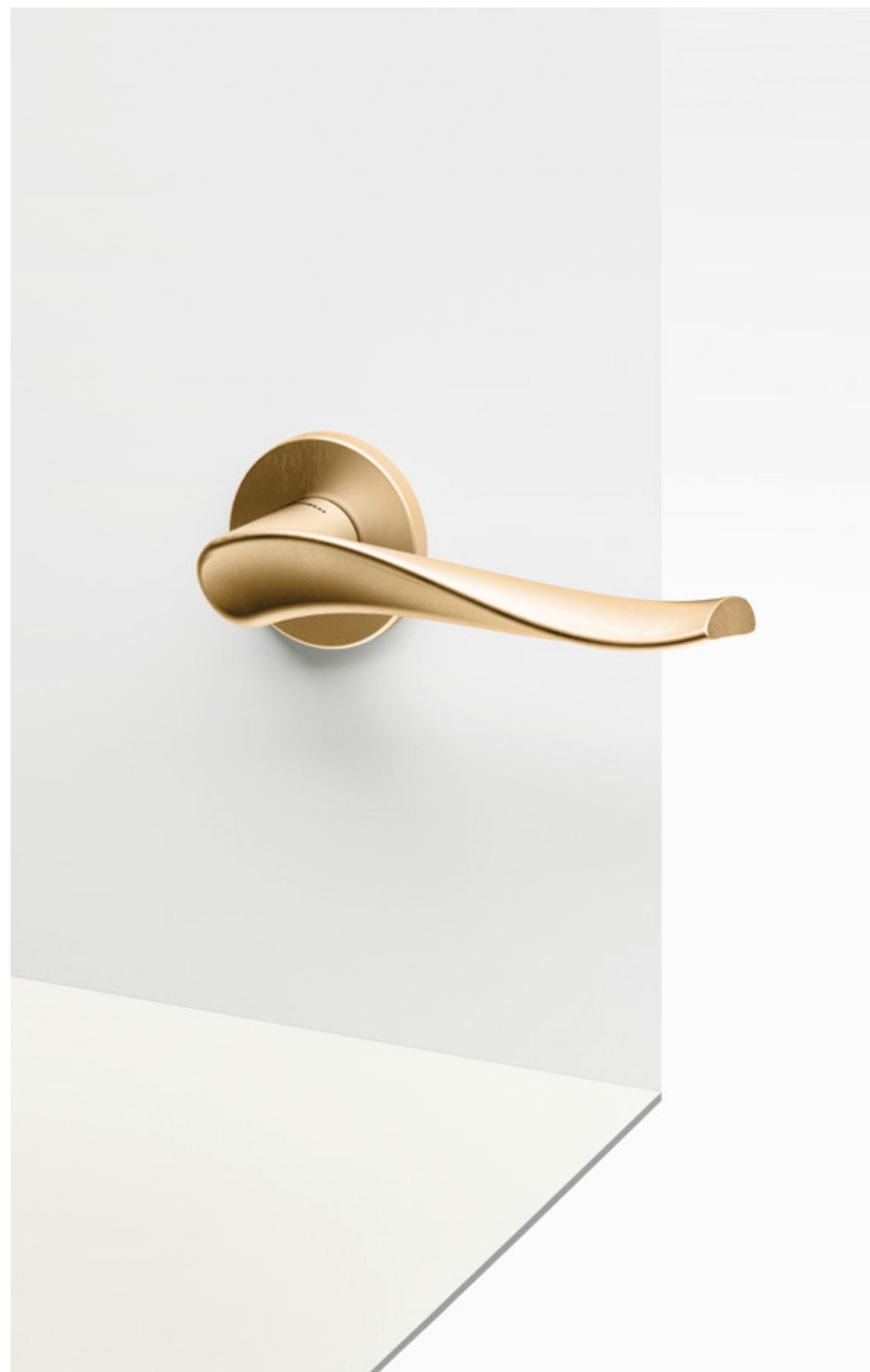

start



03/04 Oro lucido/satinato
Polished/Saten brass



26/26D Cromo lucido/satinato
Polished/Satin chrome



MBR Brunito opaco
Mat bronze

collezione / collection

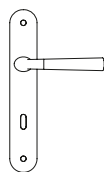

S100 con piastra
on back plate

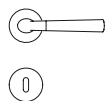

S101 con rosetta
on rose



S102/M cremonese
window lever-handle

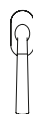

S102/DK martellina
drehkipp system



telis



03 Oro lucido
Polished brass



04 Oro satinato
Satin brass



26 Cromo lucido
Polished chrome



26D Cromo satinato
Satin chrome



MSN Nickel satinato opaco
Mat satin nickel

Disponibile nella versione Leather
Available in its Leather version

collezione / collection

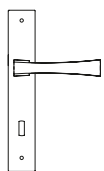

1160 con piastra
on back plate

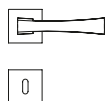

1161 con rosetta
on rose



1162/M cremonese
window lever-handle

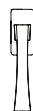

1162/DK martellina
drehkipp system



totem



03/04 Oro lucido/satinato
Polished/Saten brass



26/26D Cromo lucido/satinato
Polished/Satin chrome

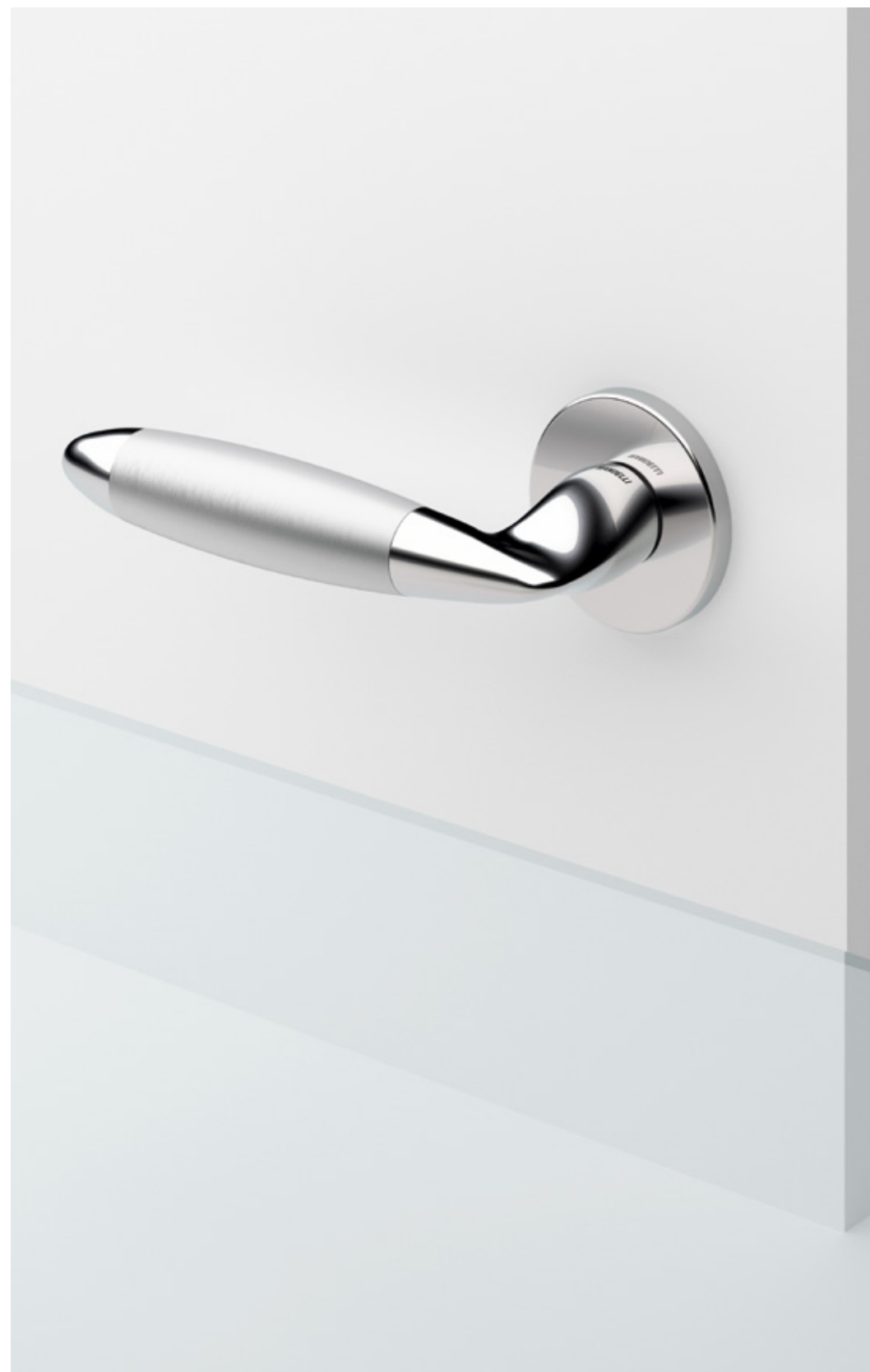

collezione / collection

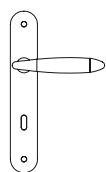

460 con piastra
on back plat

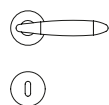

461 con rosetta
on rose

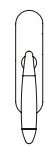

462/M cremonese
window lever-handle



462/DK martellina
drehkipp system



465 maniglione
pull handle

tuc



03/04 Oro lucido/satinato
Polished/Saten brass



26/26D Cromo lucido/satinato
Polished/Satin chrome

Disponibile nella versione Leather
Available in its Leather version

collezione / collection

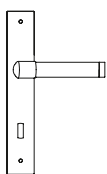

360 con piastra
on back plate

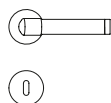

361 con rosetta
on rose

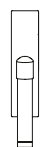

362/M cremonese
window lever-handle



362/DK martellina
drehkipp system



twee

design Massimo Cavana



03 Oro lucido
Polished brass



04 Oro satinato
Satin brass



26 Cromo lucido
Polished chrome



26D Cromo satinato
Satin chrome



MSN Nickel satinato opaco
Mat satin nickel



15A Grafite
Graphite

collezione / collection

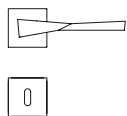

1691 con rosetta
on rose



1692/M cremonese
window lever-handle



1692/DK martellina
drehkipp system



virgo

design Giuseppe Bavuso



04 Oro satinato
Satin brass



26D Cromo satinato
Satin chrome



15A Grafite
Graphite



MSN Nickel satinato opaco
Mat satin nickel



MB Nero opaco
Mat black

collezione / collection

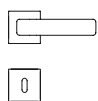

1651 con rosetta
on rose



1652/DK martellina
drehkipp system



zante



04 Oro satinato
Satin brass



26D Cromo satinato
Satin chrome



MSN Nickel satinato opaco
Mat satin nickel

collezione / collection

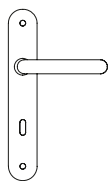

1300 con piastra
on back plat

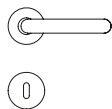

1311 con rosetta
on rose



1302/M cremonese
window lever-handle



1302/DK martellina
drehkipp system



1305 maniglione
pull handle

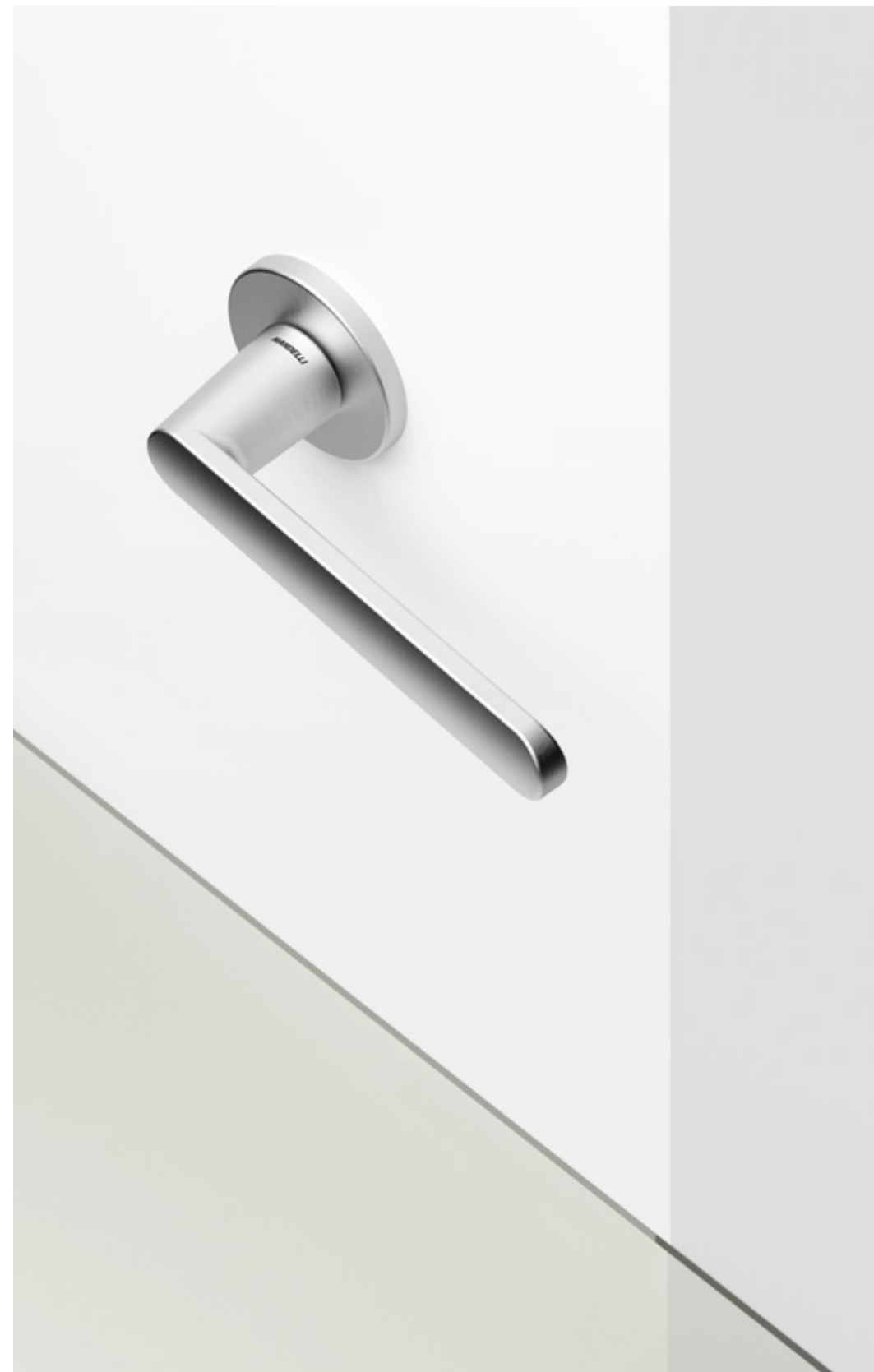

zeit

design Marco Piva

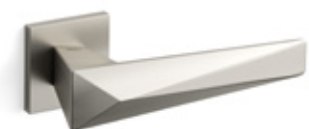
GOOD
DESIGN
AWARD
201703 Oro lucido
Polished brass04 Oro satinato
Satin brass26 Cromo lucido
Polished chrome26D Cromo satinato
Satin chromeMSN Nickel satinato opaco
Mat satin nickelMBR Brunito opaco
Mat bronze

collezione / collection

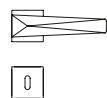
1721 con rosetta
on rose1722/M cremonese
window lever-handle1722/DK martellina
drehkipp system1725 maniglione
pull handle

zen



04/03 Oro satinato/lucido
Satin/Polished brass



26D/26 Cromo satinato/lucido
Satin/Polished chrome



MSN Nickel satinato opaco
Mat satin nickel



MBR Brunito opaco
Mat bronze

collezione / collection

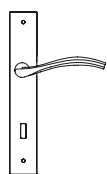

710 con piastra
on back plate

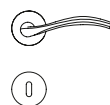

711 con rosetta
on rose



712/M cremonese
window lever-handle



712/DK martellina
drehkipp system



zoe



03 Oro lucido
Polished brass



04 Oro satinato
Satin brass



26 Cromo lucido
Polished chrome



26D Cromo satinato
Satin chrome



15A Grafite
Graphite

collezione / collection

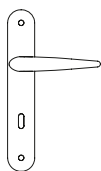

380 con piastra
on back plate

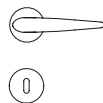

381 con rosetta
on rose



382/M cremonese
window lever-handle



382/DK martellina
drehkipp system

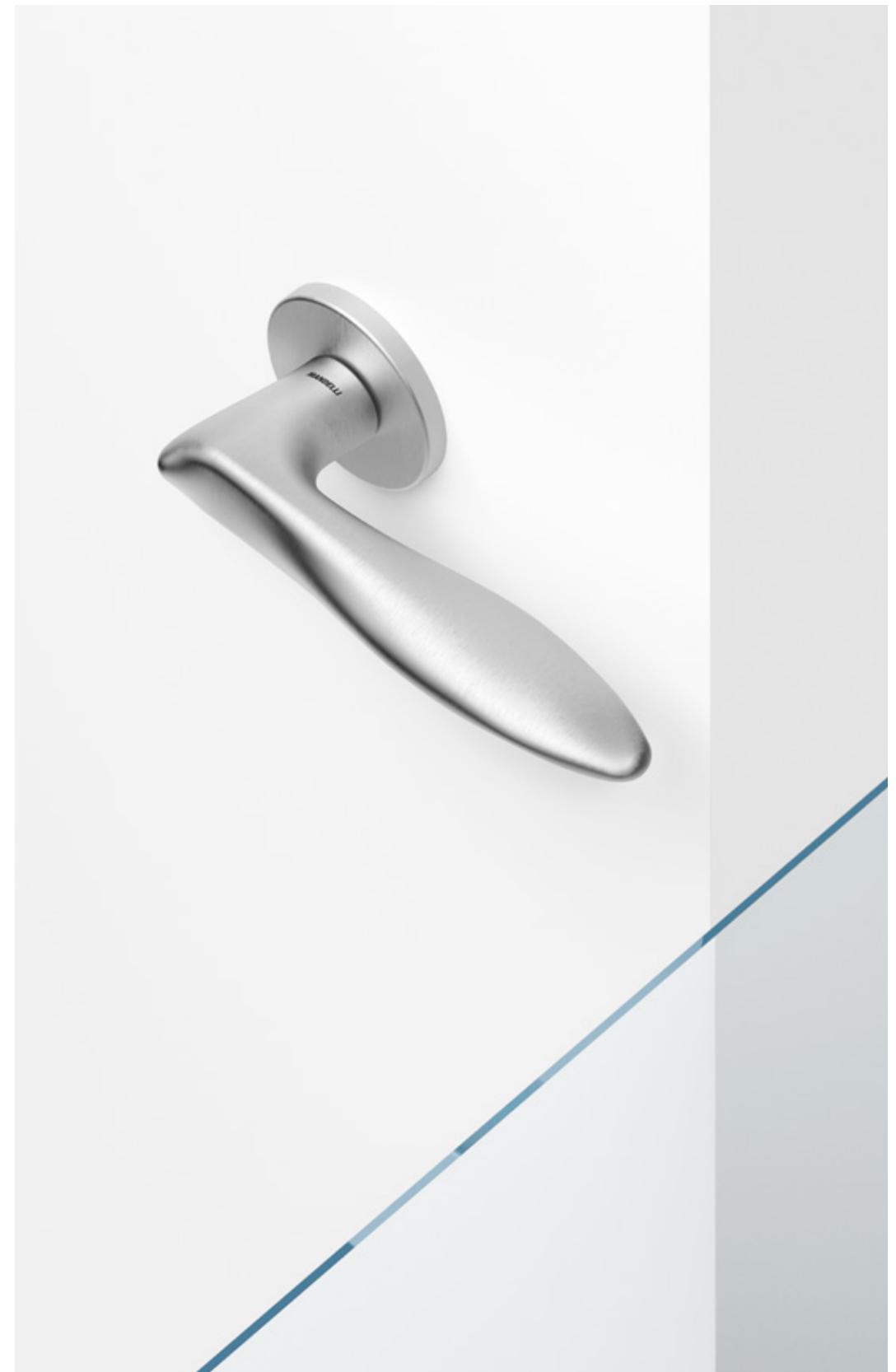

zoom



03 Oro lucido
Polished brass



04 Oro satinato
Satin brass



26 Cromo lucido
Polished chrome



26D Cromo satinato
Satin chrome



MBR Brunito opaco
Mat bronze

collezione / collection

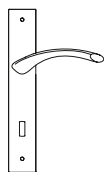

350 con piastra
on back plate

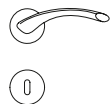

351 con rosetta
on rose



352/M cremonese
window lever-handle



352/DK martellina
drehkipp system



classic collection

Il gusto eterno della tradizione, abbinato ad un'alta sapienza artigianale, fa di queste maniglie il complemento perfetto per gli spazi che evocano ricordi senza tempo, reinterpretati in chiave moderna.

Everlasting taste provided by the tradition, combined with artisanal heritage, ensures these handles are in perfect harmony with spaces that evoke timeless memories, reinterpreting the past in a contemporary aesthetic.

classic collection

- 1511 aurora 156
- 1641 cocò 158
- 641 doge 160
- 1421 gou 162
- 1341 hartù 164
- 1021 lord 166
- 1201 melody 168
- 8011 naxos 170
- 1211 norma 172
- 8001 paros 174
- 981 plissé 176
- 1201 river 178
- 691 rondò 180
- 531 sevilla 182

aurora



24KT Oro
24KT gold



26 Cromo lucido
Polished chrome



04/03 Oro satinato/lucido
Satin/Polished brass



28 Argento vecchio
Antique chrome



RGS/RG Oro rosa
Rose gold



MBR Brunito opaco
Mat bronze

Disponibile nella versione Leather
Available in its Leather version

collezione / collection

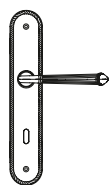

1510 con piastra
on back plate



1511 con rosetta
on rose



1512/M cremonese window
lever-handle



1512/DK martellina
drehkipp system



cocò



04/03 Oro satinato/lucido
Satin/Polished brass



26 Cromo lucido
Polished chrome



PB/BR Brunito
Bronze



MBR Brunito opaco
Mat bronze

collezione / collection

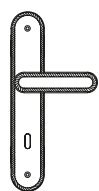

1640 con piastra
on back plate

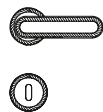

1641 con rosetta
on rose

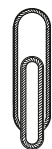

1642/M cremonese window
lever-handle



1642/DK martellina
drehkipp system



doge



24KT Oro lucido/Ceramica Bianca
24KT gold brass/White Ceramic



03 Oro lucido/Ceramica Bianca
Polished brass/White Ceramic



28 Argento vecchio/Ceramica Bianca
Antique chrome/White Ceramic



AB Brunito antico/Ceramica Bianca
Antique bronze/White Ceramic



collezione / collection

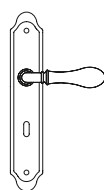

640 con piastra
on back plate

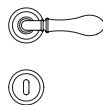

641 con rosetta
on rose



642/M cremonese window
lever-handle



642/DK martellina
drehkipp system

gou



03 Oro lucido
Polished brass



04 Oro satinato
Satin brass



28 Argento vecchio
Antique chrome



MW Bianco opaco
Mat white



collezione / collection

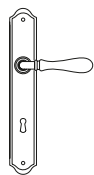

1420 con piastra
on back plate

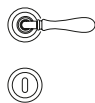

1421 con rosetta
on rose

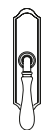

1422/M cremonese window
lever-handle



1422/DK martellina
drehkipp system

hartù



03 Oro lucido
Polished brass



04 Oro satinato
Satin brass



28 Argento vecchio
Antique chrome



MBR Brunito opaco
Mat bronze

Disponibile nella versione Leather
Available in its Leather version

collezione / collection

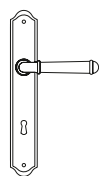

1340 con piastra
on back plate

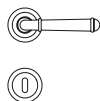

1341 con rosetta
on rose



1342/M cremonese window
lever-handle



1342/DK martellina
drehkipp system



lord



03/04 Oro lucido/satinato
Polished/Satin brass



04/03 Oro satinato/lucido
Satin/Polished brass



PB/BR Brunito
Bronze



MBR Brunito opaco
Mat bronze

collezione / collection



1020 con piastra
on back plate

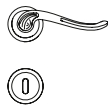

1021 con rosetta
on rose



1022/M cremonese window
lever-handle



1022/DK martellina
drehkipp system



melody



03 Oro lucido/Ceramica Bianca
Polished brass/White Ceramic



04 Oro satinato/Ceramica Bianca
Satin brass/White Ceramic



24KT Oro/Ceramica Bianca
24KT gold/White Ceramic



MBR Brunito opaco/Ceramica Bianca
Mat bronze/White Ceramic



26 Cromo lucido/Ceramica Bianca
Polished chrome/White Ceramic



28 Argento vecchio/Ceramica Bianca
Antique chrome/White Ceramic

Disponibile nella versione Leather
Available in its Leather version

collezione / collection

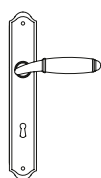

1200 con piastra
on back plate

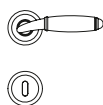

1201 con rosetta
on rose



1202/M cremonese window
lever-handle



1202/DK martellina
drehkipp system



naxos



03 Oro lucido/Bianco Calacatta
Polished brass/White Calacatta



24KT Oro/Bianco Calacatta
24KT gold/White Calacatta



AB Brunito antico/Bianco Calacatta
Antique bronze/White Calacatta



MBR Brunito opaco/Nero Marquinia
Mat bronze/Black Marquinia



26 Cromo lucido/Nero Marquinia
Polished chrome/Black Marquinia

Disponibile nella versione Marmo Marquinia nero / Calacatta bianco
Available in its Marble version Black Marquinia / White Calacatta

collezione / collection

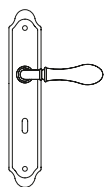

8010 con piastra
on back plate

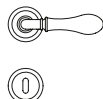

8011 con rosetta
on rose



8012/M cremonese window
lever-handle



8012/DK martellina
drehkipp system



norma



03 Oro lucido
Polished brass



04 Oro satinato
Satin brass



PB/BR Brunito lucido
Polished bronze



MBR Brunito opaco
Mat bronze



26 Cromo lucido
Polished chrome

collezione / collection

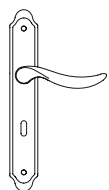

1210 con piastra
on back plate

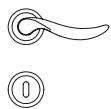

1211 con rosetta
on rose



1212/M cremonese window
lever-handle



1212/DK martellina
drehkipp system



paros



03 Oro lucido/Nero Marquinia
Polished brass/Balck Marquinia



04 Oro satinato/Bianco Calacatta
Satin brass/White Calacatta



24KT Oro/Nero Marquinia
24KT gold/Balck Marquinia



MBR Brunito opaco/Bianco Calacatta
Mat bronze/White Calacatta



26 Cromo lucido/Nero Marquinia
Polished chrome/Balck Marquinia

Disponibile nella versione Marmo Marquinia nero / Calacatta bianco
Available in its Marble version Black Marquinia / White Calacatta

collezione / collection

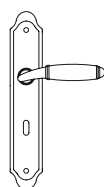

8000 con piastra
on back plate

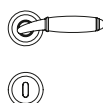

8001 con rosetta
on rose



8002/M cremonese window
lever-handle



8002/DK martellina
drehkipp system



plissé



03 Oro lucido
Polished brass



03/04 Oro lucido/satinato
Polished/Satin brass



PB/BR Brunito
Bronze



MBR Brunito opaco
Mat bronze



26 Cromo lucido
Polished chrome



collezione / collection

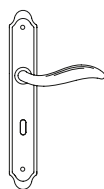

980 con piastra
on back plate

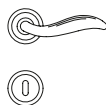

981 con rosetta
on rose



982/M cremonese window
lever-handle



982/DK martellina
drehkipp system

river



03 Oro lucido
Polished brass



04 Oro satinato
Satin brass



PB/BR Brunito
Bronze



MBR Brunito opaco
Mat bronze



26D Cromo satinato
Satin chrome

collezione / collection

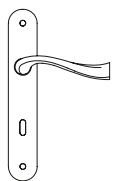

1200 con piastra
on back plat

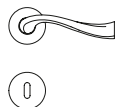

1211 con rosetta
on rose



1202/M cremonese
window lever-handle



1202/DK martellina
drehkipp system



995 maniglione
pull handle



rondò



03 Oro lucido
Polished brass



04 Oro satinato
Satin brass



PB/BR Brunito
Bronze



AB Brunito antico
Antique bronze



26 Cromo lucido
Polished chrome



26D Cromo satinato
Satin chrome

collezione / collection

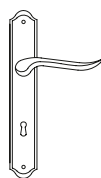

690 con piastra
on back plate

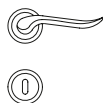

691 con rosetta
on rose



692/M cremonese window
lever-handle



692/DK martellina
drehkipp system



sevilla



04 Oro satinato
Satin brass



28 Argento vecchio
Antique chrome



PB/BR Brunito lucido
Polished bronze



AB Brunito antico
Antique bronze



MBR Brunito opaco
Mat bronze



IB Bronzo scultura
Imperial bronze

collezione / collection

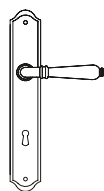

530 con piastra
on back plate

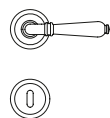

531 con rosetta
on rose

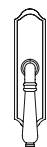

532/M cremonese window
lever-handle



532/DK martellina
drehkip system

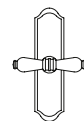

532 centrale
central lever



complements & accessories

Una collezione dedicata a tutti quei complementi e quegli accessori indispensabili per perfezionare un progetto, in ogni dettaglio. Interamente realizzati in ottone, made in Italy, per una proposta completa e curata.

A collection dedicated to all. Decorative features and essential accessories that complete a design down to the finest detail. The brass items are made entirely in Italy and offer a complete and attentively prepared range.

complements

pull handles 188
maniglioni

pull up 194
maniglioni per alzanti

clips 196
maniglie per porte scorrevoli

door fittings 202
nottolini

knobs 203
pomoli

bilbao



1675 - 1675S

chicane



1965

fusilla



1735 / 1735S

link



1035

nadir



775

pyramid



1255

river



995

totem



465 | 465 L

zante



1305

1315

zeit



1725

nelson



1785



3025



3025



160

aries



195/A

callas



196/A

life



197/A

basic M|L



198/A

368 T

368



368 TL



368 TLN



368 TC/S

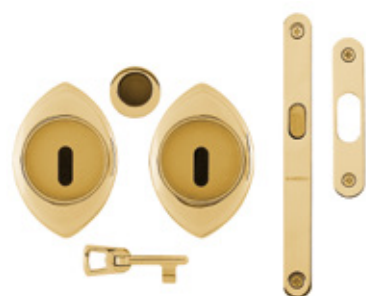

368 TN/S



378

378



378 C/S



1018 T

1018



1018 TL

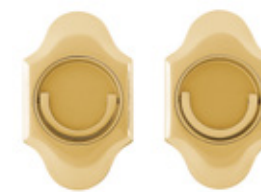

1018 TLN



1018 TC/S



1018 TN/S



1028 T

1028 TL



1028 TL



1028 TLN



1028 TC/S



1028 TN/S



1028

1028



1028 C/S



1038 T

1038



1038 TL



1038 TLN



1038 TC/S



1038 TN/S



1038

1038



1038 C/S



1108 T

1108 T

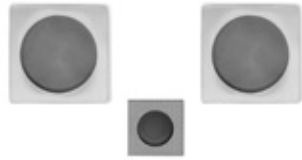

1108 TN/S

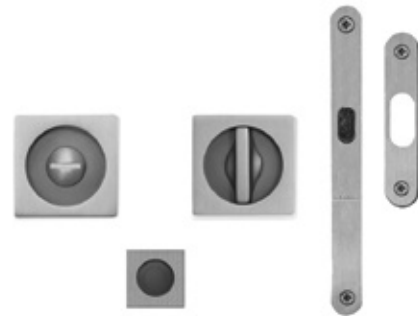

1108 TNN/S

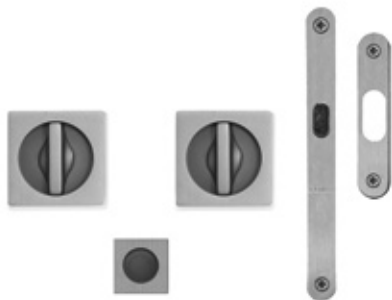

1018 TC/S

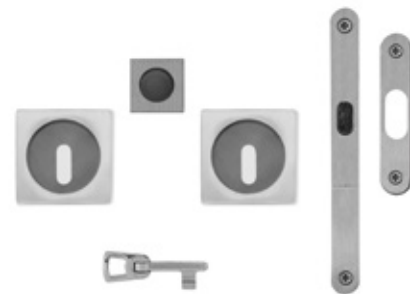

1118T

1108 T



1108 TN



911-114

RFV



1291-115

RFV



284



644



744



RFV / RW



RFV / RW



854/GIR



1104



1024



651-113

RFV



1351-113

RFV



accessories

back plates 206
piastre

escutcheons 207
bocchette

security plates 207
dotazioni speciali

accessories 209
accessori

3040



440



1020



S40



1350



651



911



1351



1291



6061



6071



221 | BS | BS/Y



231 | BS | BS/Y



bocchette /escutcheons

kaba



australia



piastra / back plates

BL1



Z/Y



P55



690UP



911US



fermaporte / doorstop

110



6031US



109



chiavi / keys

200/C



650/C



batacchio / clapper

102



700/C



1710UP



1700UP



PC1



Z



690-SIC



PC2



P48



3040-SIC



technical data



Minimal a profilo tondo
Round minimal profile



Minimal a profilo quadrato
Square minimal profile



Copertura protettiva pvd
Protective PVD coating



Disponibili in più finiture
Available in different finishes



Kit rosetta da bagno con farfalla
Thumb turn | coin release on rose
R3 113 / R4 114 / R5 115



Kit piastra da bagno con farfalla
Thumb turn | coin release on black plate
R3 113 / R4 114 / R5 115



Rosetta e bocchetta strette 31X62 mm
per infissi con montante minimale
Narrow rose and eschuteon 31x62 mm
for minimal fittings
SM senza molla | unsprung
CM con molla | with release spring



Piastra stretta 30X138 mm
per infissi con montante minimale senza
molla di ritorno
Narrow plate 30x138 mm
for unsprung fittings



DK di sicurezza
Security DK

40+1



1831
maniglia per porta con rosetta
door handle on rose

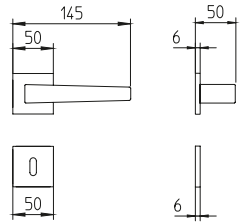

1830
con piastra
door handle on backplate

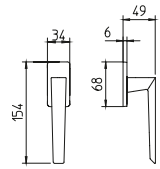

ande



451
maniglia per porta con rosetta
door handle on rose

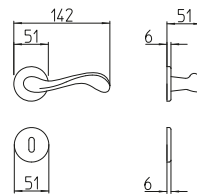

450
con piastra
door handle on backplate

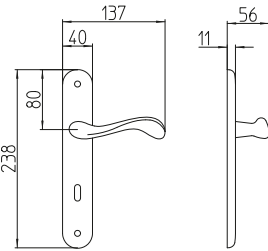

452/M
cremonese
window lever handle

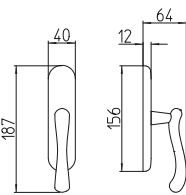

452/DK
martellina dk
drehkipp system

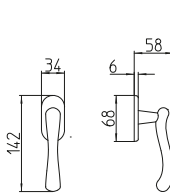

aqualung



1791
maniglia per porta con rosetta
door handle on rose

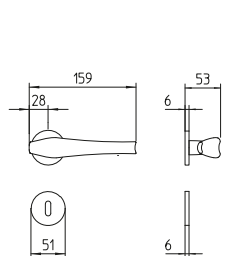

1790
con piastra
door handle on backplate

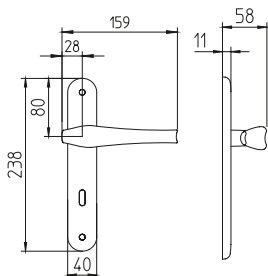

1792/M
cremonese
window lever handle

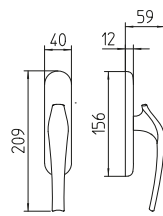

1792/DK
martellina dk
drehkipp system

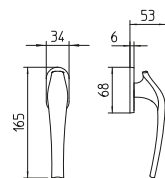

ara



3191
maniglia per porta con rosetta
door handle on rose

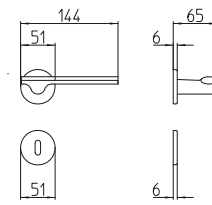

3190
con piastra
door handle on backplate

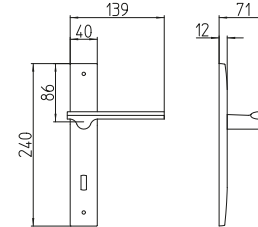

3192/M
cremonese
window lever handle

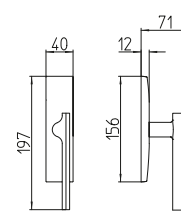

3192/DK
martellina dk
drehkipp system

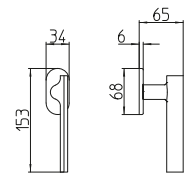

aries



1941
maniglia per porta con rosetta
door handle on rose

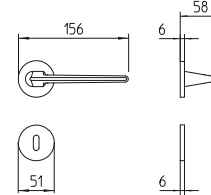

1940
con piastra
door handle on backplate

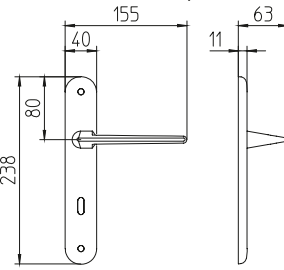

1942/M
cremonese
window lever handle

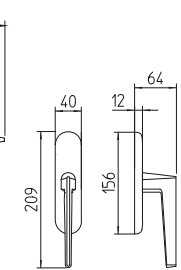

1942/DK
martellina dk
drehkipp system

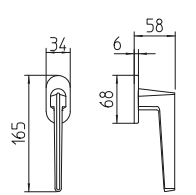

astrid



1631
maniglia per porta con rosetta
door handle on rose

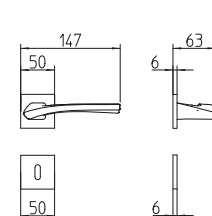

1630
con piastra
door handle on backplate

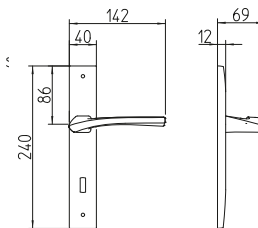

1632/M
cremonese
window lever handle

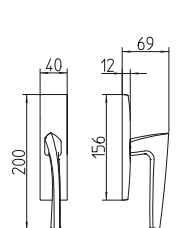

1632/DK
martellina dk
drehkipp system

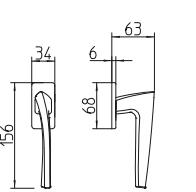

aurora



1511
maniglia per porta con rosetta
door handle on rose

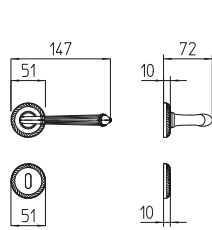

1510
con piastra
door handle on backplate

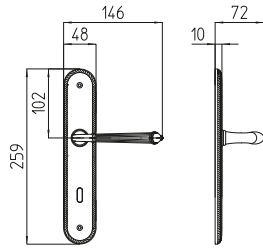

1512/M
cremonese
window lever handle

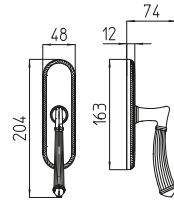

1512/DK
martellina dk
drehtipp system

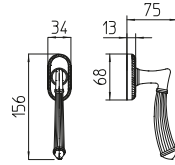

bilbao



1671
maniglia per porta con rosetta
door handle on rose

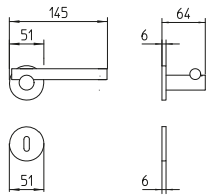

1672/M
cremonese
window lever handle

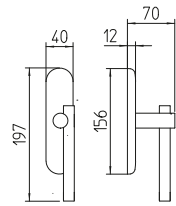

1672/DK
martellina dk
drehtipp system

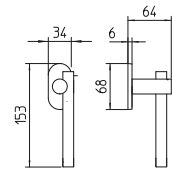

bix



1141
maniglia per porta con rosetta
door handle on rose

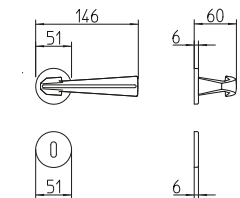

1140
con piastra
door handle on backplate

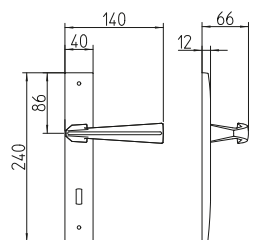

1142/M
cremonese
window lever handle

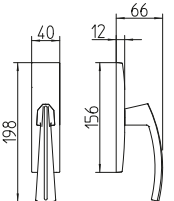

1142/DK
martellina dk
drehtipp system

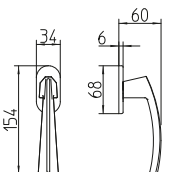

callas



1611
maniglia per porta con rosetta
door handle on rose

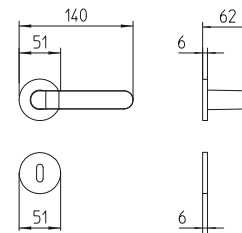

1612/M
cremonese
window lever handle

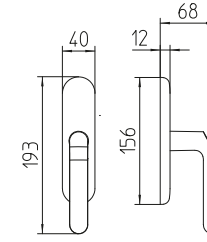

1612/DK
martellina dk
drehtipp system

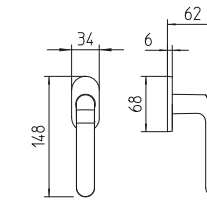

carré



1621
maniglia per porta con rosetta
door handle on rose

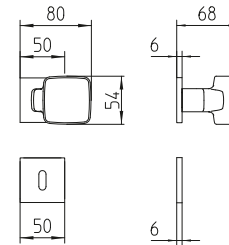

chio



1181
maniglia per porta con rosetta
door handle on rose

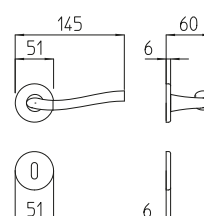

1180
con piastra
door handle on backplate

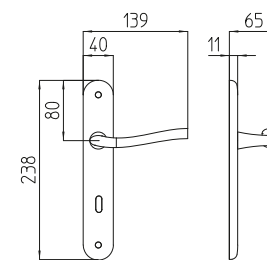

1182M
cremonese
window lever handle

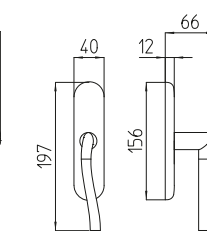

1182/DK
martellina dk
drehtipp system

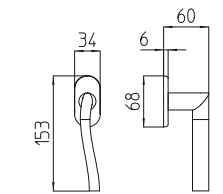

cocò



1641
maniglia per porta con rosetta
door handle on rose

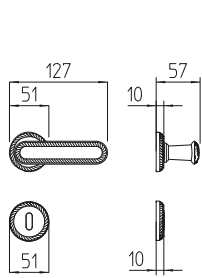

1640
con piastra
door handle on backplate

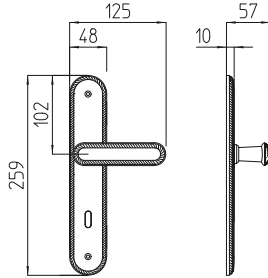

1642/M
cremonese
window lever handle

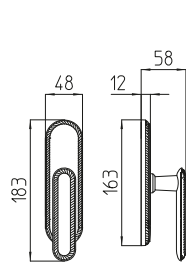

1642/DK
martellina dk
drehkipp system

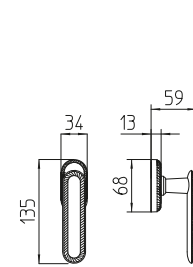

demí



3181
maniglia per porta con rosetta
door handle on rose

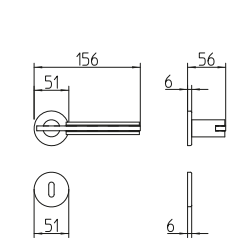

3180
con piastra
door handle on backplate

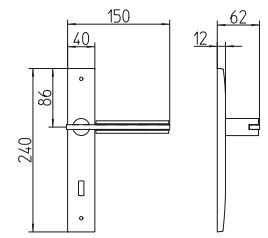

3182/M
cremonese
window lever handle

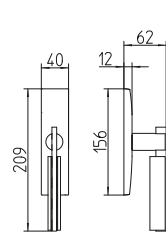

3182/DK
martellina dk
drehkipp system

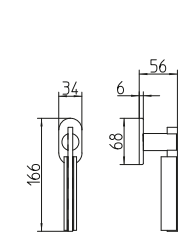

doge



641
maniglia per porta con rosetta
door handle on rose

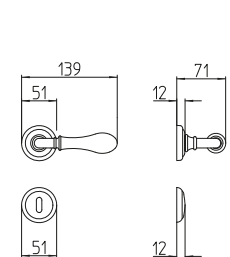

640
con piastra
door handle on backplate

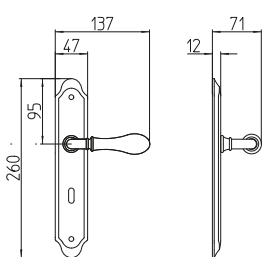

642/M
cremonese
window lever handle

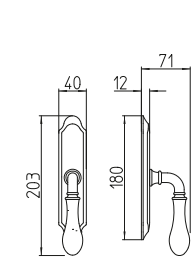

642/DK
martellina dk
drehkipp system

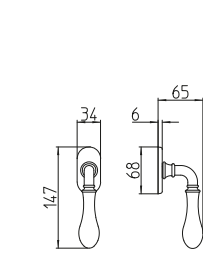

fan



1291
maniglia per porta con rosetta
door handle on rose

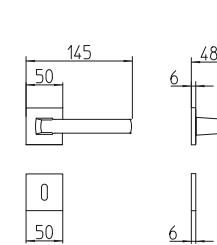

1290
con piastra
door handle on backplate

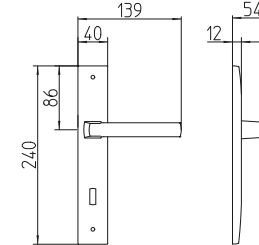

1292/M
cremonese
window lever handle

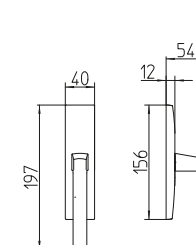

1292/DK
martellina dk
drehkipp system

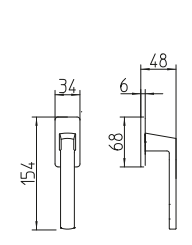

fenix



1601
maniglia per porta con rosetta
door handle on rose

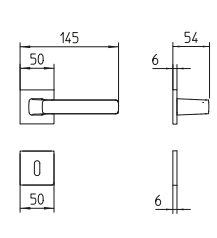

1602/M
cremonese
window lever handle

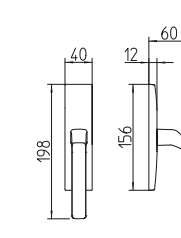

1602/DK
martellina dk
drehkipp system

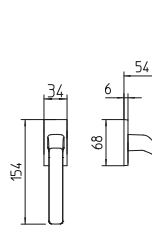

filo



721
maniglia per porta con rosetta
door handle on rose

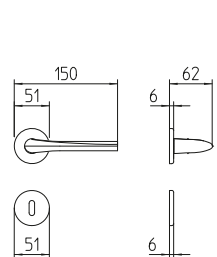

720
con piastra
door handle on backplate

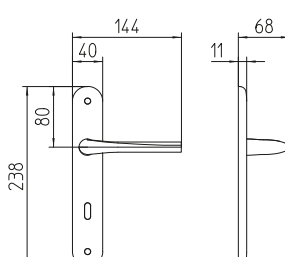

722/M
cremonese
window lever handle

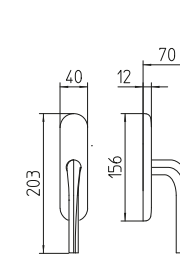

722/DK
martellina dk
drehkipp system

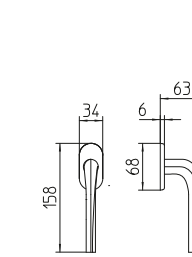

frame



1871
maniglia per porta con rosetta
door handle on rose

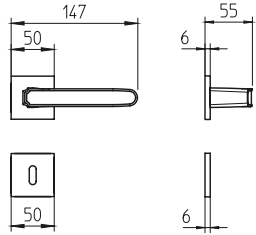

1872/M
cremonese
window lever handle

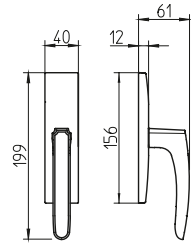

1872/DK
martellina dk
drehkipp system

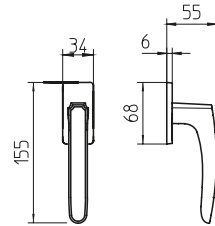

1871
maniglia per porta con rosetta
door handle on rose

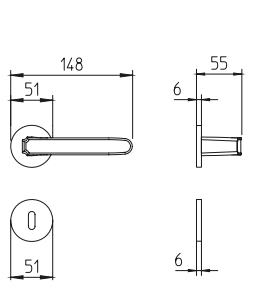

1870
con piastra
door handle on backplate

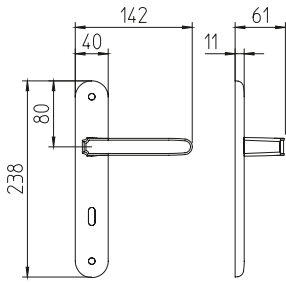

1872/M
cremonese
window lever handle

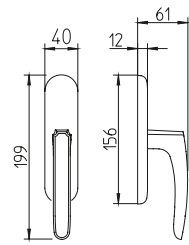

1872/DK
martellina dk
drehkipp system

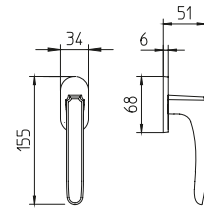

fusilla



1731
maniglia per porta con rosetta
door handle on rose

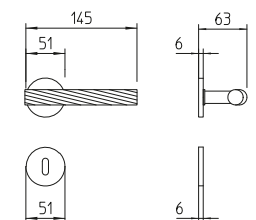

1732/DK
martellina dk
drehkipp system

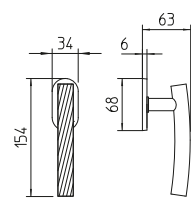

gou



1421
maniglia per porta con rosetta
door handle on rose

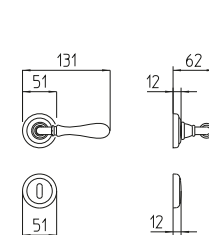

1420
con piastra
door handle on backplate

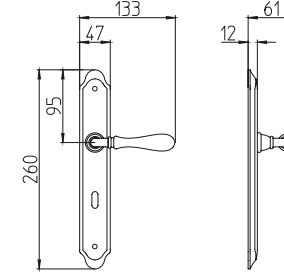

1422/M
cremonese
window lever handle

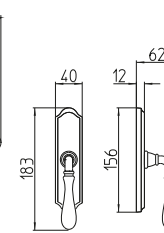

1422/DK
martellina dk
drehkipp system

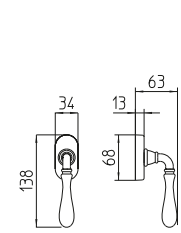

grint



1751
maniglia per porta con rosetta
door handle on rose

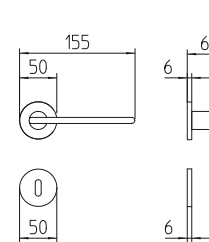

1752/M
cremonese
window lever handle

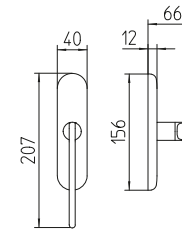

1752/DK
martellina dk
drehkipp system

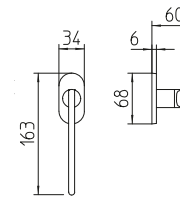

hartù



1341
maniglia per porta con rosetta
door handle on rose

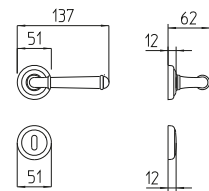

1340
con piastra
door handle on backplate

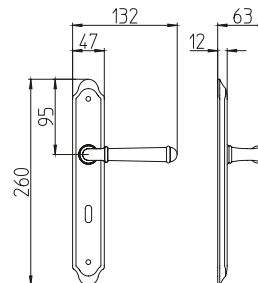

1342/M
cremonese
window lever handle

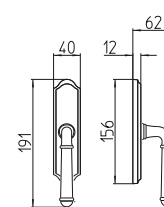

1342/DK
martellina dk
drehkipp system

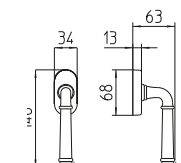

isi



1081
maniglia per porta con rosetta
door handle on rose

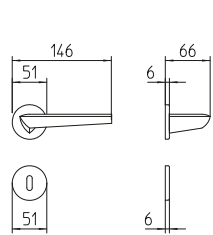

1080
con piastra
door handle on backplate

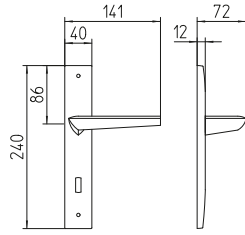

1082/M
cremonese
window lever handle

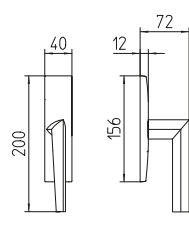

1082/DK
martellina dk
drehkipp system

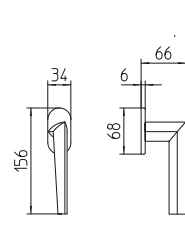

K

1950
maniglia
door handle

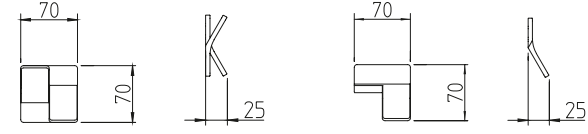

jet



1371
maniglia per porta con rosetta
door handle on rose

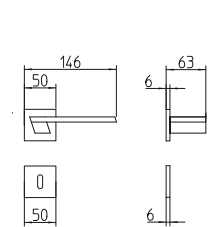

1370
con piastra
door handle on backplate

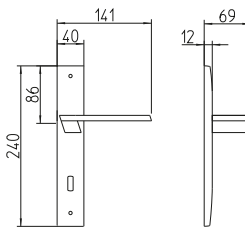

1372/M
cremonese
window lever handle

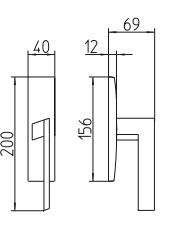

1372/DK
martellina dk
drehkipp system

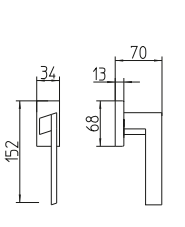

kiri



1461
maniglia per porta con rosetta
door handle on rose

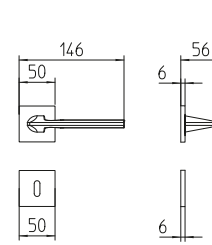

1460
con piastra
door handle on backplate

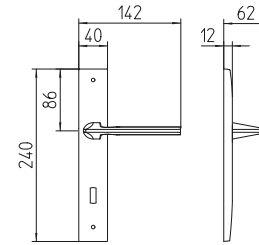

1462/M
cremonese
window lever handle

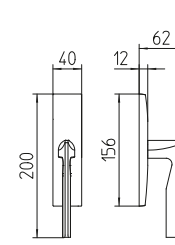

1462/DK
martellina dk
drehkipp system

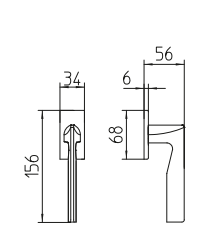

juno



8021/M
maniglia per porta senza
rosetta
door handle without rose

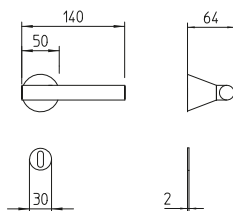

8022/DK
maniglia per porta con rosetta
door handle on rose

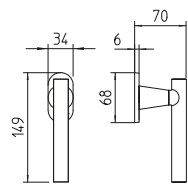

kuki



1741
maniglia per porta con rosetta
door handle on rose

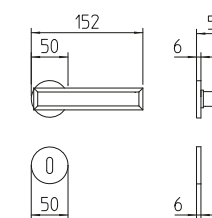

1740
con piastra
door handle on backplate

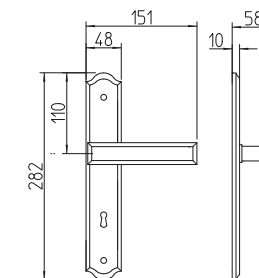

1742/M
cremonese
window lever handle

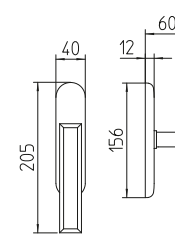

1742/DK
martellina dk
drehkipp system

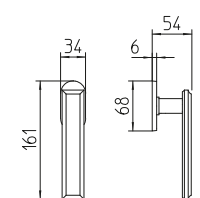

lario



1681
maniglia per porta con rosetta
door handle on rose

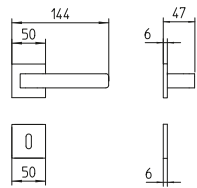

1682/M
cremonese
window lever handle

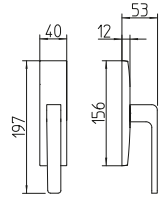

1682/DK
martellina dk
drehkipp system

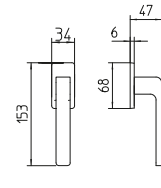

1682/DK-SIC
martellina dk
drehkipp system

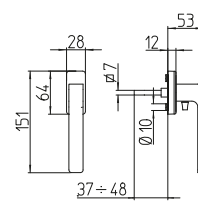

led



1091
maniglia per porta con rosetta
door handle on rose

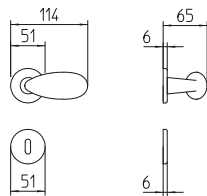

1090
con piastra
door handle on backplate

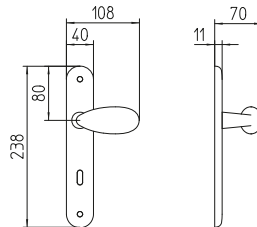

life



1171
maniglia per porta con rosetta
door handle on rose

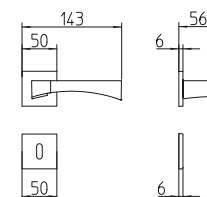

1170
con piastra
door handle on backplate

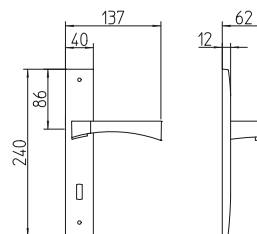

1172/M
cremonese
window lever handle

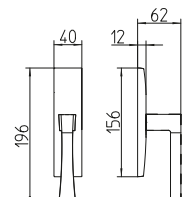

1172/DK
martellina dk
drehkipp system

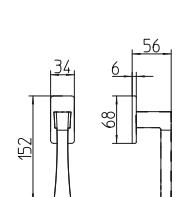

link



1031
maniglia con rosetta
door handle on rose

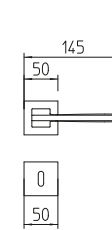

1030
con piastra
door handle on backplate

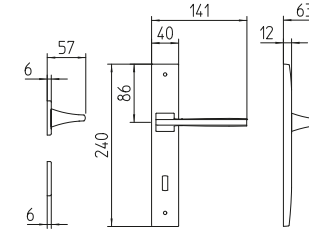

1032/M
cremonese
window lever handle

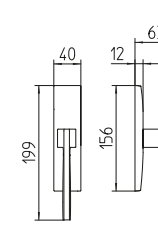

1032/DK
martellina dk
drehkipp system

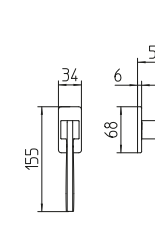

1032/DK-SIC
martellina dk
drehkipp system

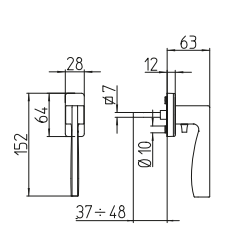

lord



1021
maniglia per porta con rosetta
door handle on rose

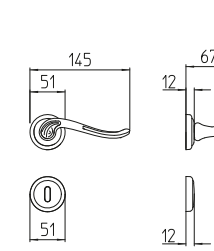

1020
con piastra
door handle on backplate

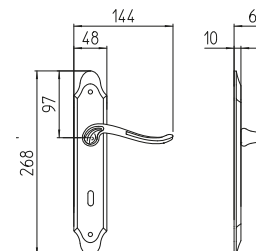

1022/M
cremonese
window lever handle

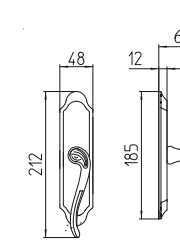

1022/DK
martellina dk
drehkipp system

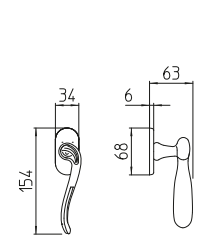

melody



1201
maniglia per porta con rosetta
door handle on rose

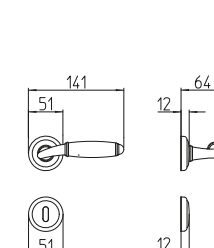

1200
con piastra
door handle on backplate

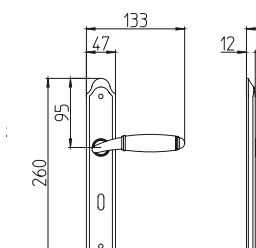

1202/M
cremonese
window lever handle

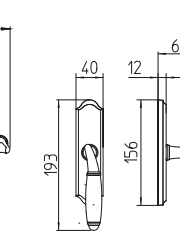

1202/DK
martellina dk
drehkipp system

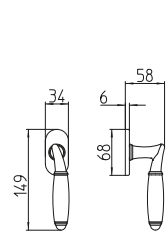

mitos



1131
maniglia per porta con rosetta
door handle on rose

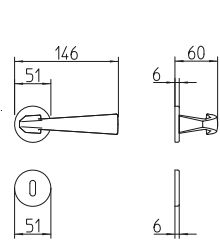

1130
con piastra
door handle on backplate

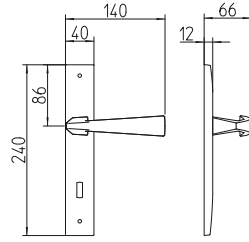

1132/M
cremonese
window lever handle

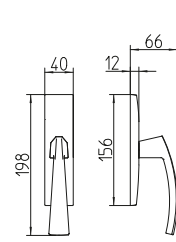

1132/DK
martellina dk
drehkipp system

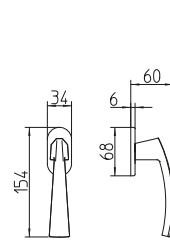

MM80



1921
maniglia per porta con rosetta
door handle on rose

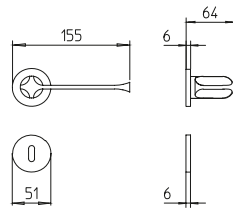

1922/DK
martellina dk
drehkipp system

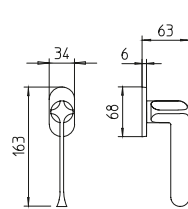

nadir



771
maniglia per porta con rosetta
door handle on rose

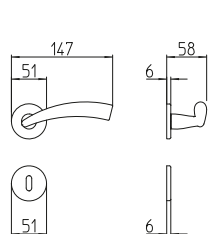

770
con piastra
door handle on backplate

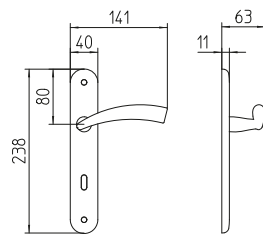

772/M
cremonese
window lever handle

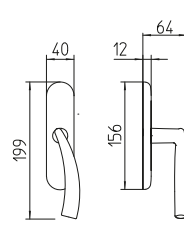

772/DK
martellina dk
drehkipp system

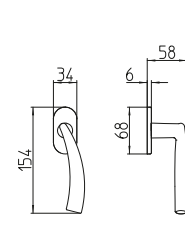

naxos



8011
maniglia per porta con rosetta
door handle on rose

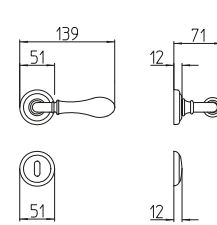

8010
con piastra
door handle on backplate

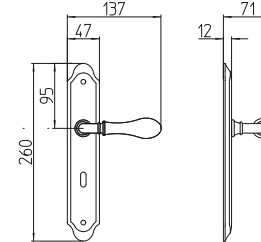

8012/M
cremonese
window lever handle

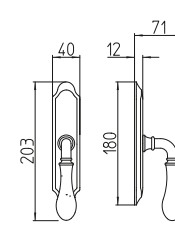

8012/DK
martellina dk
drehkipp system

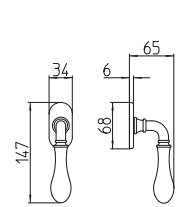

norma



1211
maniglia per porta con rosetta
door handle on rose

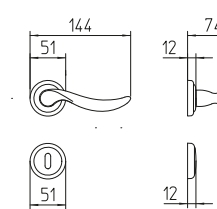

1210
con piastra
door handle on backplate

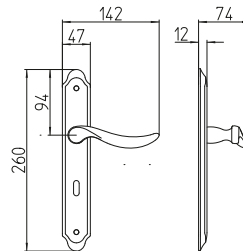

1212/M
cremonese
window lever handle

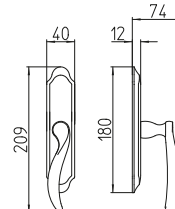

1212/DK
martellina dk
drehkipp system

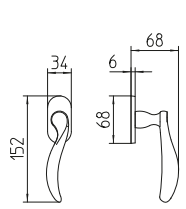

nuria



771
maniglia per porta con rosetta
door handle on rose

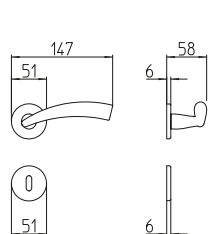

770
con piastra
door handle on backplate

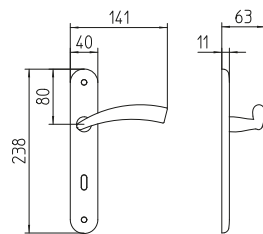

772/M
cremonese
window lever handle

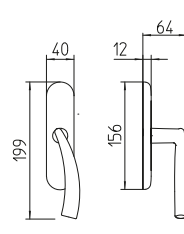

772/DK
martellina dk
drehkipp system

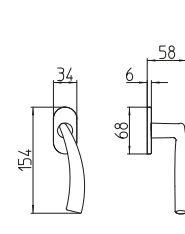

1501
maniglia per porta con rosetta
door handle on rose

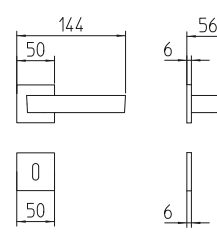

1500
con piastra
door handle on backplate

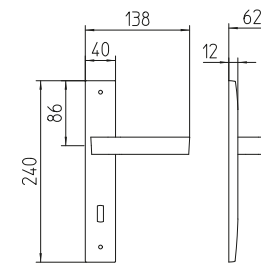

1502/M
cremonese
window lever handle

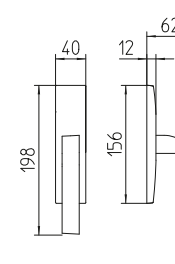

1502/DK
martellina dk
drehkipp system

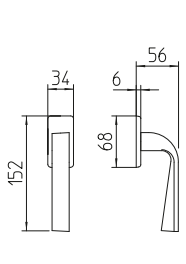

ola



1071
maniglia per porta con rosetta
door handle on rose

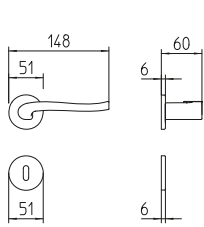

1070
con piastra
door handle on backplate

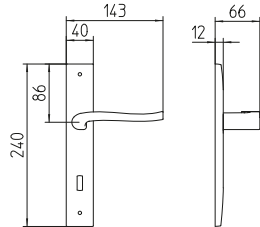

1072/M
cremonese
window lever handle

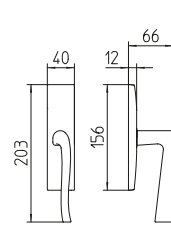

1072/DK
martellina dk
drehkipp system

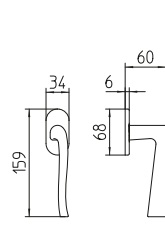

paros



8001
maniglia per porta con rosetta
door handle on rose

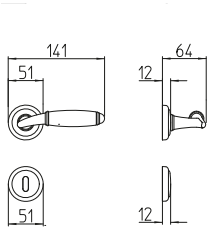

8000
con piastra
door handle on backplate

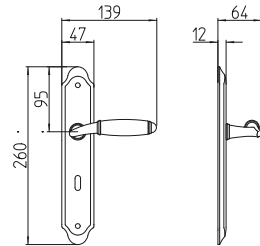

8002/M
cremonese
window lever handle

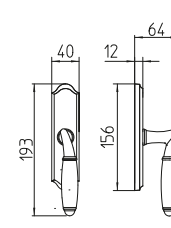

8002/DK
martellina dk
drehkipp system

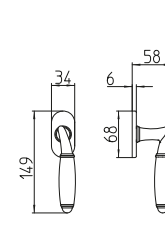

pyramid



1251
maniglia per porta con rosetta
door handle on rose

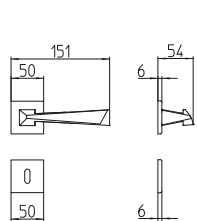

1250
con piastra
door handle on backplate

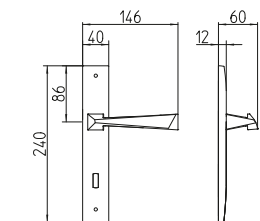

1252/M
cremonese
window lever handle

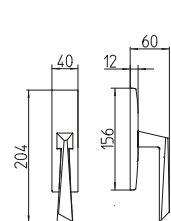

1252/DK
martellina dk
drehkipp system

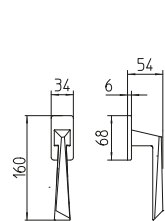

plissé



981
maniglia per porta con rosetta
door handle on rose

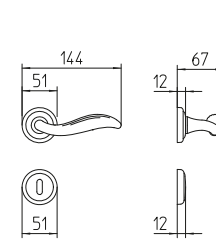

980
con piastra
door handle on backplate

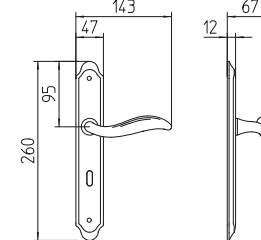

982/M
cremonese
window lever handle

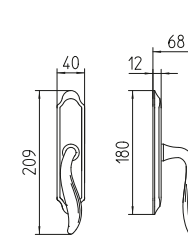

982/DK
martellina dk
drehkipp system

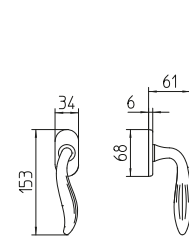

PP33



1801
maniglia per porta con rosetta
door handle on rose

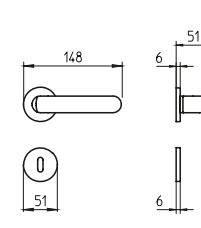

1800
con piastra
door handle on backplate

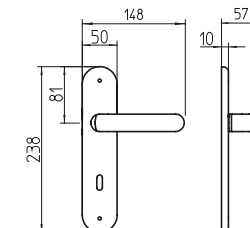

1802/M
cremonese
window lever handle

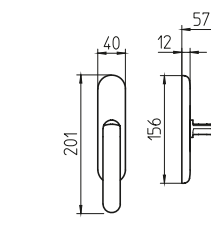

1802/DK
martellina dk
drehkipp system

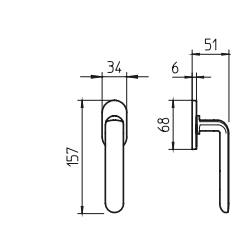

river



991
maniglia per porta con rosetta
door handle on rose

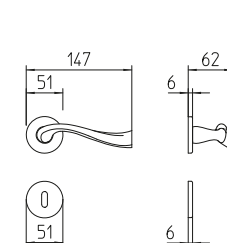

990
con piastra
door handle on backplate

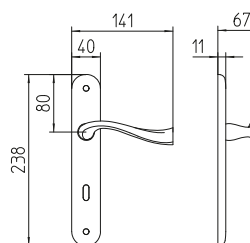

992/M
cremonese
window lever handle

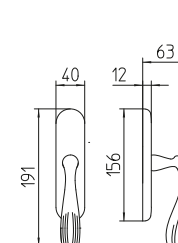

992/DK
martellina dk
drehkipp system

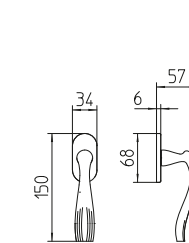

rondò



691
maniglia per porta con rosetta
door handle on rose

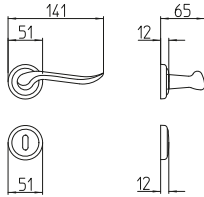

690
con piastra
door handle on backplate

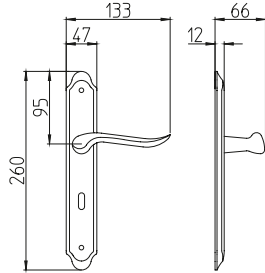

692/M
cremonese
window lever handle

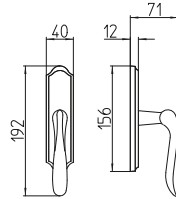

692/DK
martellina dk
drehkipp system

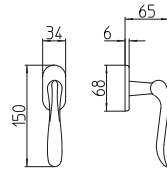

seven



1761
maniglia per porta con rosetta
door handle on rose

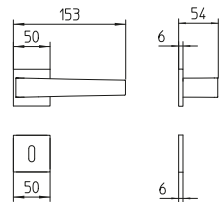

1762/M
cremonese
window lever handle

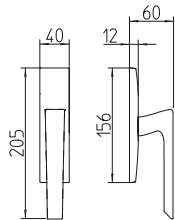

1762/DK
martellina dk
drehkipp system

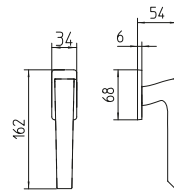

sevilla



531
maniglia per porta con rosetta
door handle on rose

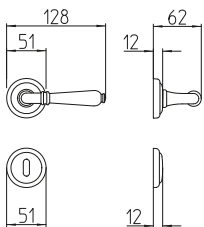

530
con piastra
door handle on backplate

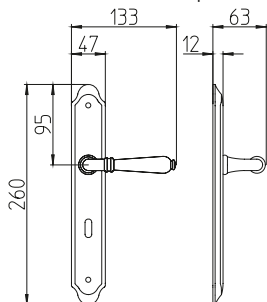

532/M
cremonese
window lever handle

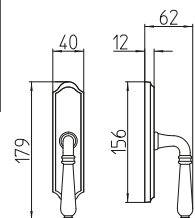

532
cremonese centrale
central window lever

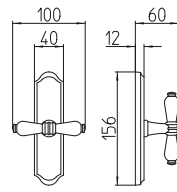

532/DK
martellina dk
drehkipp system

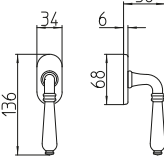

special



S91
maniglia per porta con rosetta
door handle on rose

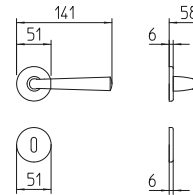

S90
con piastra
door handle on backplate

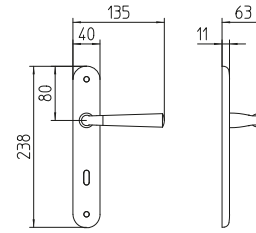

S92/M
cremonese
window lever handle

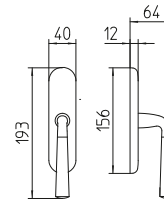

S92/DK
martellina dk
drehkipp system

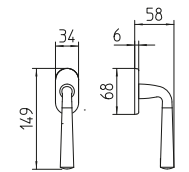

spin



731
maniglia per porta con rosetta
door handle on rose

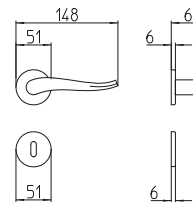

730
con piastra
door handle on backplate

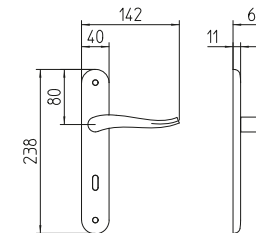

732/M
cremonese
window lever handle

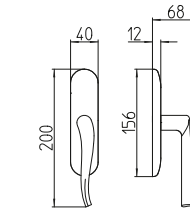

732/DK
martellina dk
drehkipp system

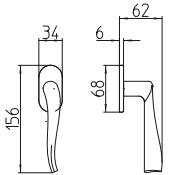

start



S101
maniglia con rosetta
door handle on rose

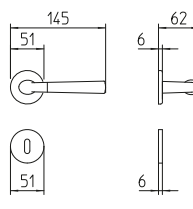

S100
con piastra
door handle on backplate

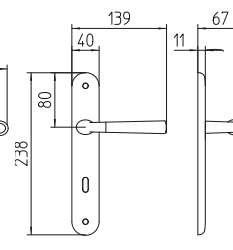

S102/M
cremonese
window lever handle

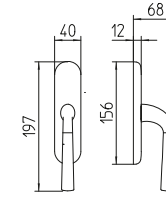

S102/DK
martellina dk
drehkipp system

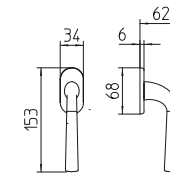

S102/DKM-SIC
martellina dk
drehkipp system

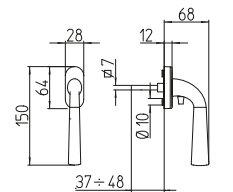

telis

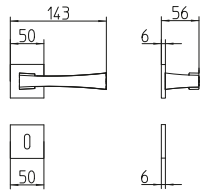

1161

maniglia per porta con rosetta
door handle on rose

1160

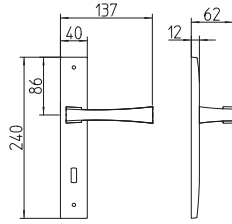
con piastra
door handle on backplate

1162/M

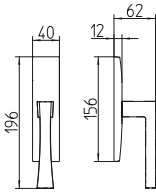
cremonese
window lever handle

1162/DK

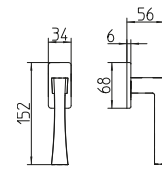
martellina dk
drehkipp system

totem

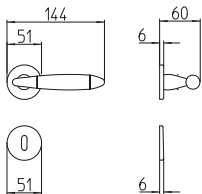

461

maniglia per porta con rosetta
door handle on rose

460

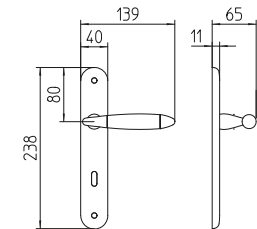
con piastra
door handle on backplate

462/M

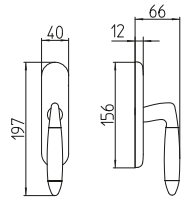
cremonese
window lever handle

462/DK

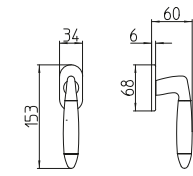
martellina dk
drehkipp system

tuc

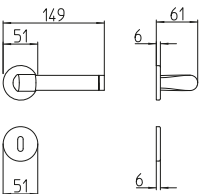

361

maniglia per porta con rosetta
door handle on rose

360

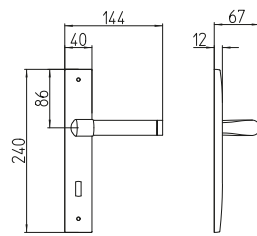
con piastra
door handle on backplate

362/M

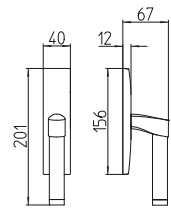
cremonese
window lever handle

362/DK

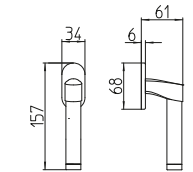
martellina dk
drehkipp system

1301

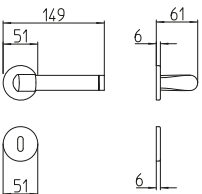
maniglia per porta con rosetta
door handle on rose

1300

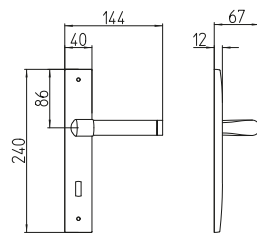
con piastra
door handle on backplate

1302/M

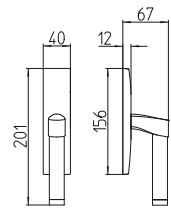
cremonese
window lever handle

1302/DK

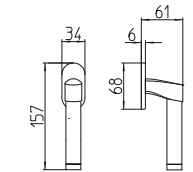
martellina dk
drehkipp system

twee

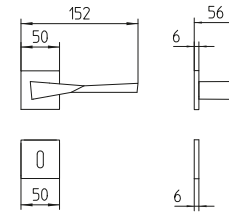

1691

maniglia per porta con rosetta
door handle on rose

1692/M

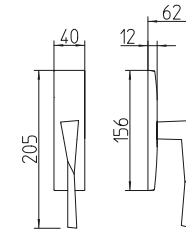
cremonese
window lever handle

1692/DK

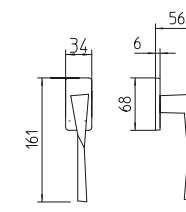
martellina dk
drehkipp system

virgo

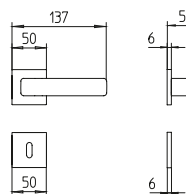

1651

maniglia per porta con rosetta
door handle on rose

1652/DK

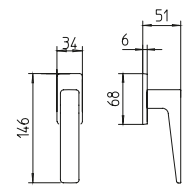
martellina dk
drehkipp system

zante

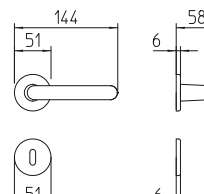

1301

maniglia per porta con rosetta
door handle on rose

1300

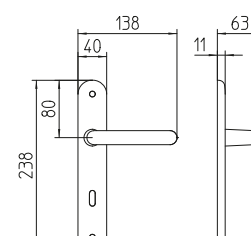
con piastra
door handle on backplate

1302/M

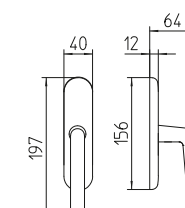
cremonese
window lever handle

1302/DK

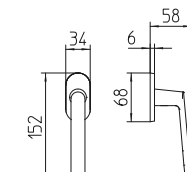
martellina dk
drehkipp system

zeit



1721

maniglia per porta con rosetta
door handle on rose

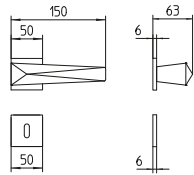

1722/M

cremonese
window lever handle

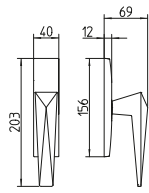

1722/DK

martellina dk
drehkipp system

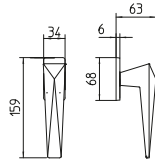

zen



711

maniglia per porta con rosetta
door handle on rose

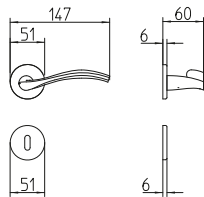

710

con piastra
door handle on backplate

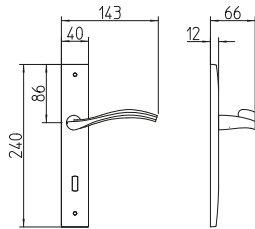

712/M

cremonese
window lever handle

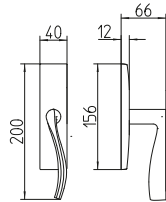

712/DK

martellina dk
drehkipp system

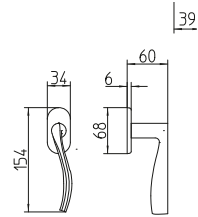

zoe



381

maniglia per porta con rosetta
door handle on rose

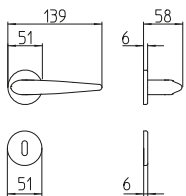

380

con piastra
door handle on backplate

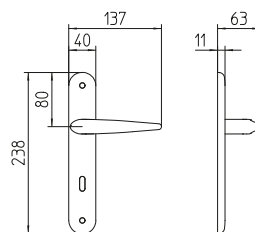

382/M

cremonese
window lever handle

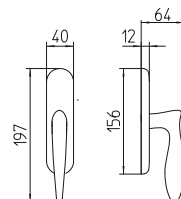

382/DK

martellina dk
drehkipp system

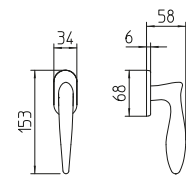

zoom



351

maniglia per porta con rosetta
door handle on rose

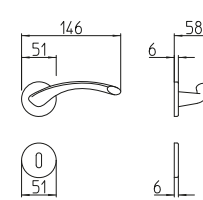

350

con piastra
door handle on backplate

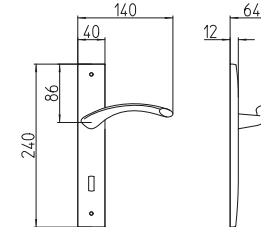

352/M

cremonese
window lever handle

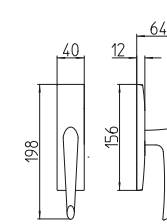

352/DK

martellina dk
drehkipp system

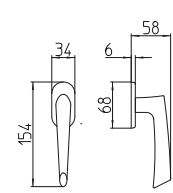

160R

160/R DX-SX

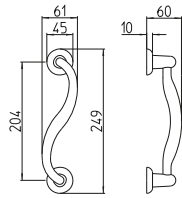

160/R-C

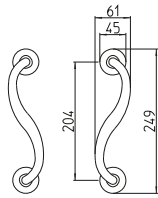

160/R-P

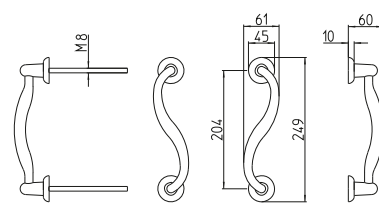

1035

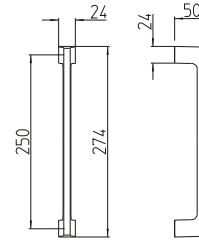

1125

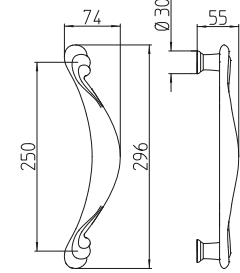

465

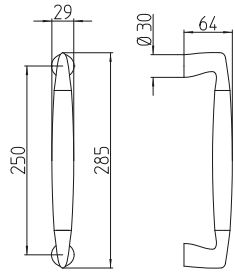

465/L

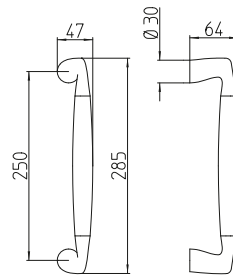

1255

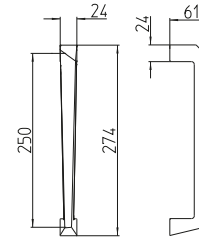

1305

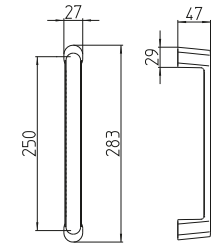

775

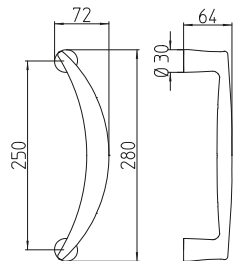

995

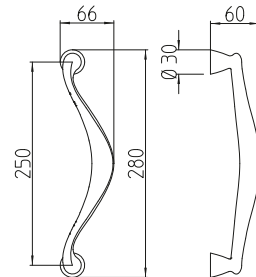

1315

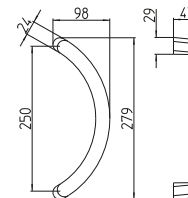

1725

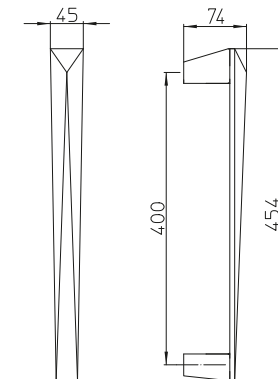

1675

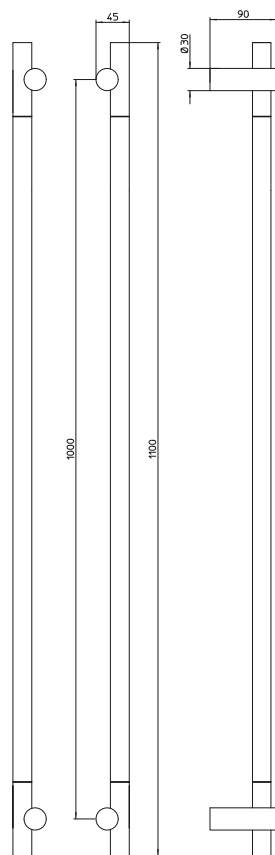
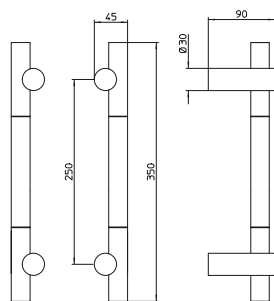
1675-1000
SX DX1675-250
SX DX

1675S

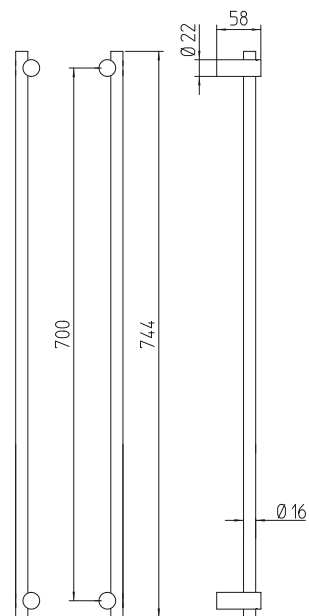
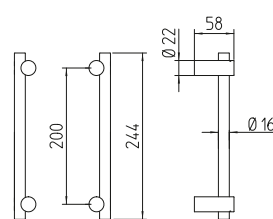
1675S-700
SX DX1675S-200
SX DX

1735

1735-1000

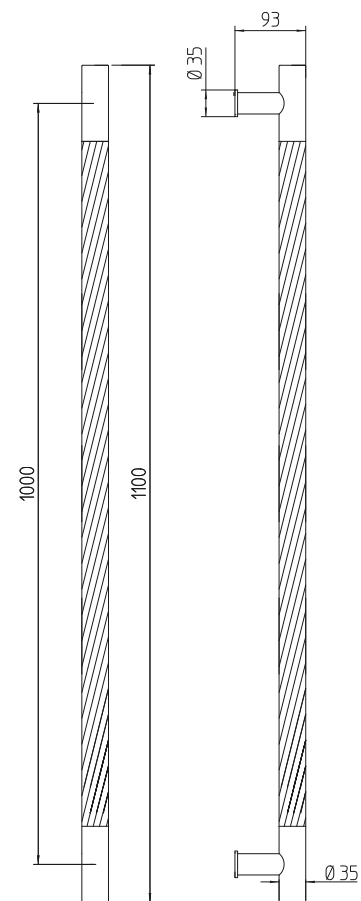

1735-400

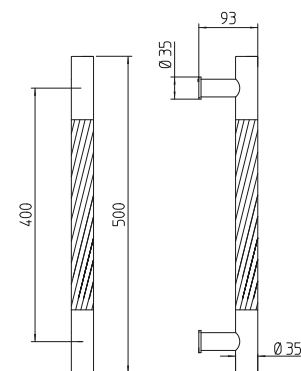

1735S

1735S-700

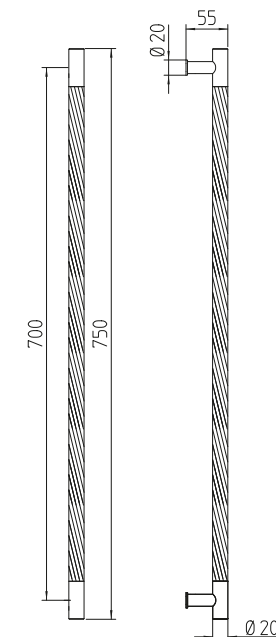

1735S-200

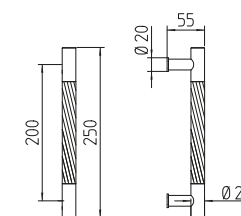

Art. 1675 su misura da 250mm a 1000mm size on request

Art. 1675S su misura da 200mm a 700mm size on request

Art. 1735 su misura da 400mm a 1000mm size on request

Art. 1735S su misura da 200mm a 700mm size on request

1785

1785-1000

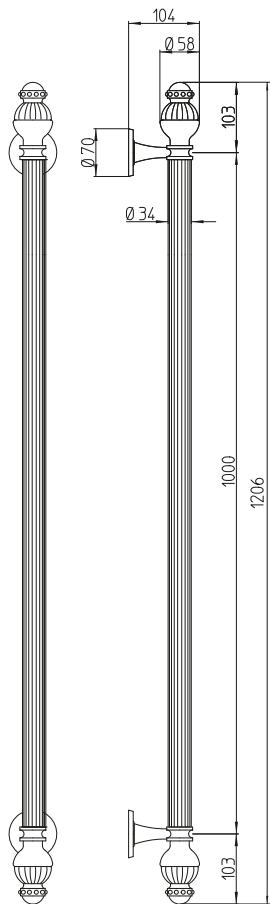

1785-400

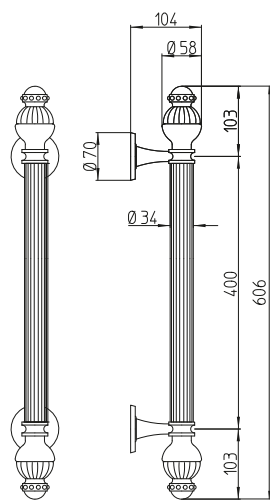

Art. 1785 su misura da 400mm a 1000mm size on request

3025

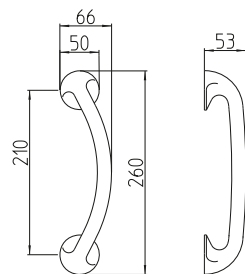

1965

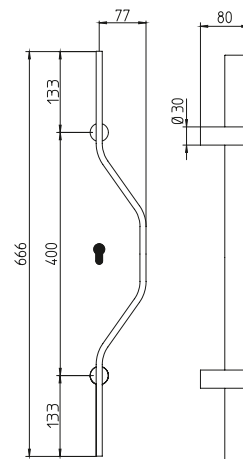
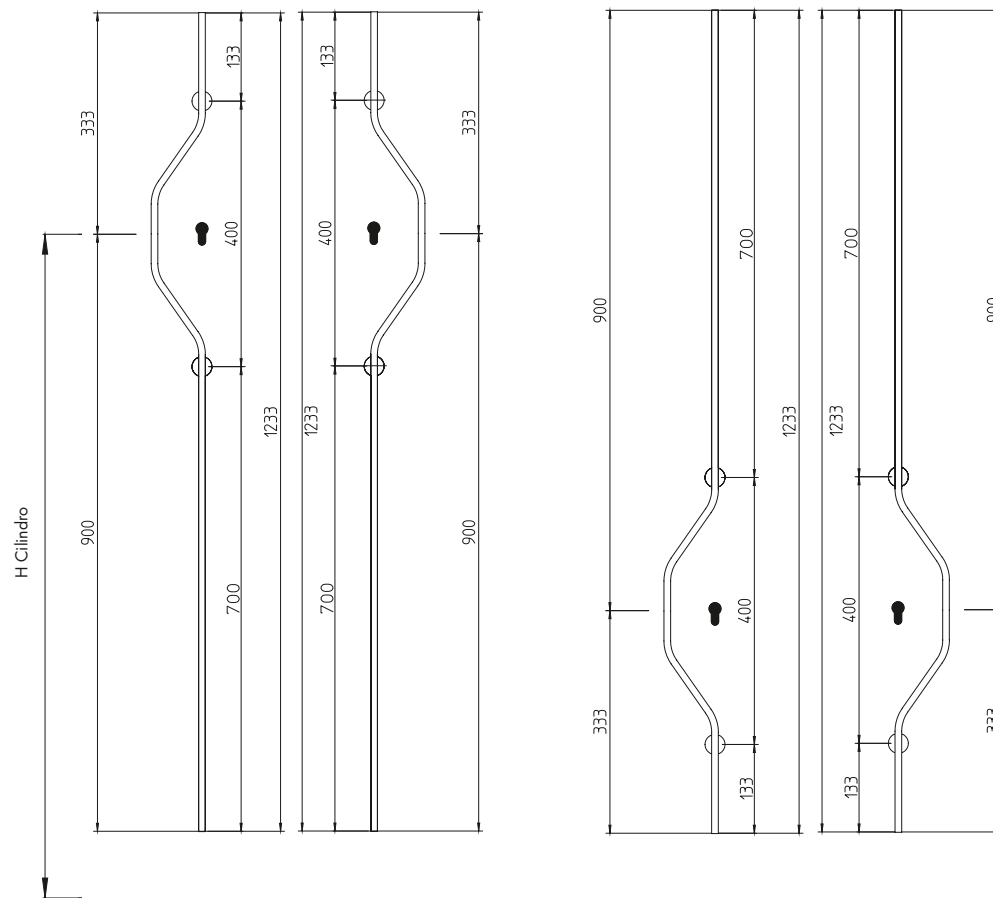

195



195/A

Per alzante scorrevole
con maniglia ad incasso esterna
(con/senza foro cilindro)
impugnatura 233-10 mm

Mechanism pull-up handle
for sliding door with flush handle
(with/without key-hole cylinder)
pull length 233-10 mm

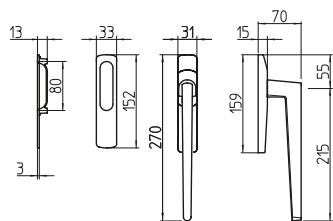

196

196/A

Alzante scorrevole
con maniglia ad incasso
(con/senza foro cilindro)
impugnatura 24-10 mm.

Mechanism pull-up handle for
sliding door with flush handle
(with/without key-hole cylinder)
pull length 24-10 mm

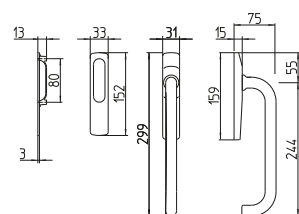

196/C

Alzante scorrevole
con maniglia ad incasso
(con/senza foro cilindro)
lunghezza impugnatura 179-10 mm

Mechanism pull-up handle
for sliding door with flush handle
(with/without key-hole cylinder)
Pull length 179-10 mm

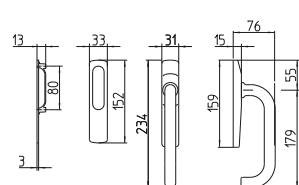

195/A-P

Per alzante scorrevole a coppia
(con/senza foro cilindro)
impugnatura 233-10 mm

Mechanism pull-up handle pair
(with/without key-hole cylinder)
pull length 233-10 mm

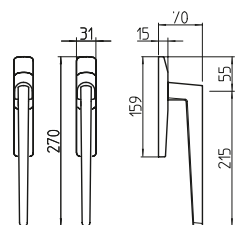

196/A-P

Alzante scorrevole a coppia
(con/senza foro cilindro)
impugnatura 24-10 mm

Mechanism pull-up handle pair
(with/without key-hole cylinder)
pull length 24-10 mm

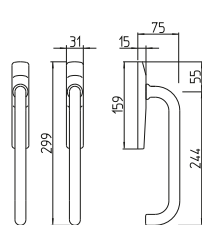

196/C-P

Maniglione alzante scorrevole a coppia
(con/senza foro cilindro)
lunghezza impugnatura 179-10 mm

Mechanism pull-up handle pair
(with/without key-hole cylinder)
pull length 179-10 mm

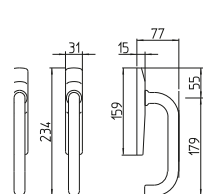

197



197/A

Alzante scorrevole
con maniglia ad incasso
(con/senza foro cilindro)
impugnatura 233-10 mm

Mechanism pull-up handle
for sliding door with flush handle
(with/without key-hole cylinder)
pull length 233-10 mm

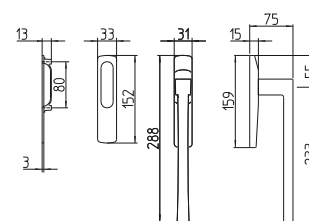

198



198/A

Alzante scorrevole
con maniglia ad incasso
(con/senza foro cilindro)
impugnatura 233-10 mm

Mechanism pull-up handle
for sliding door with flush handle
(with/without key-hole cylinder)
pull length 233-10 mm

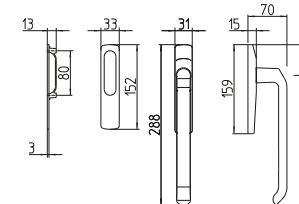

197/A-P

Alzante scorrevole a coppia
(con/senza foro cilindro)
impugnatura 233-10 mm

Mechanism pull-up handle pair
(with/without key-hole cylinder)
pull length 233-10 mm

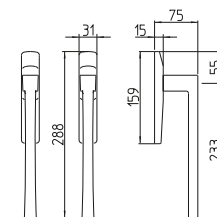

198/A-P

Alzante scorrevole a coppia
(con/senza foro cilindro)
impugnatura 233-10 mm

Mechanism pull-up handle pair
(with/without key-hole cylinder)
pull length 233-10 mm

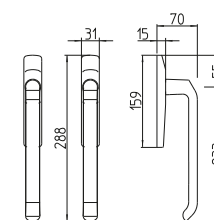

196/B

Maniglione DK
impugnatura 158-7 mm
Pull-up handle DK
for sliding door
pull length 158-7 mm

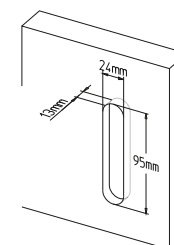
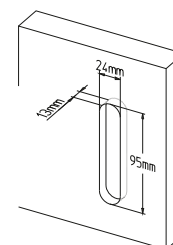
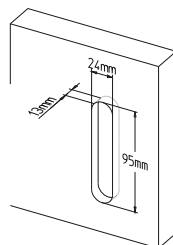
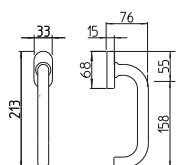
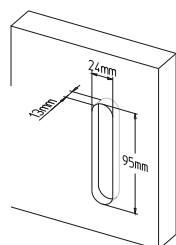

368 T

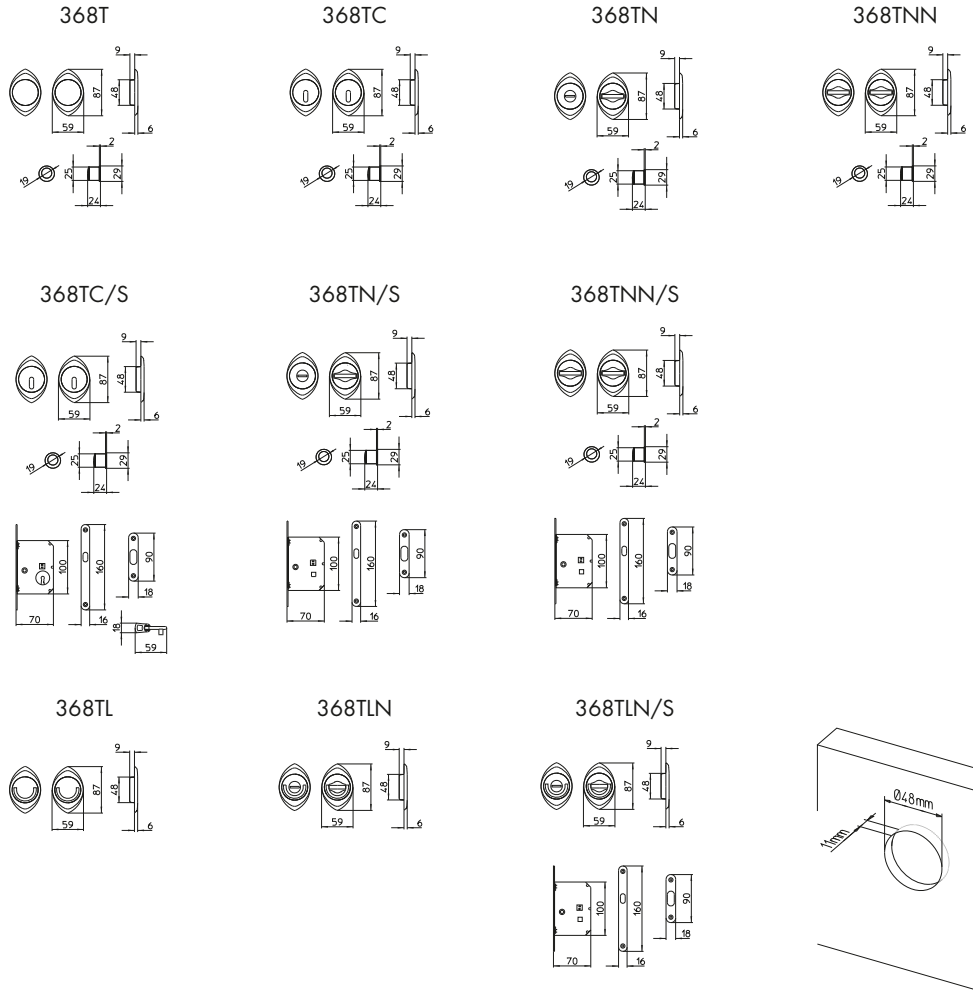

1018 T

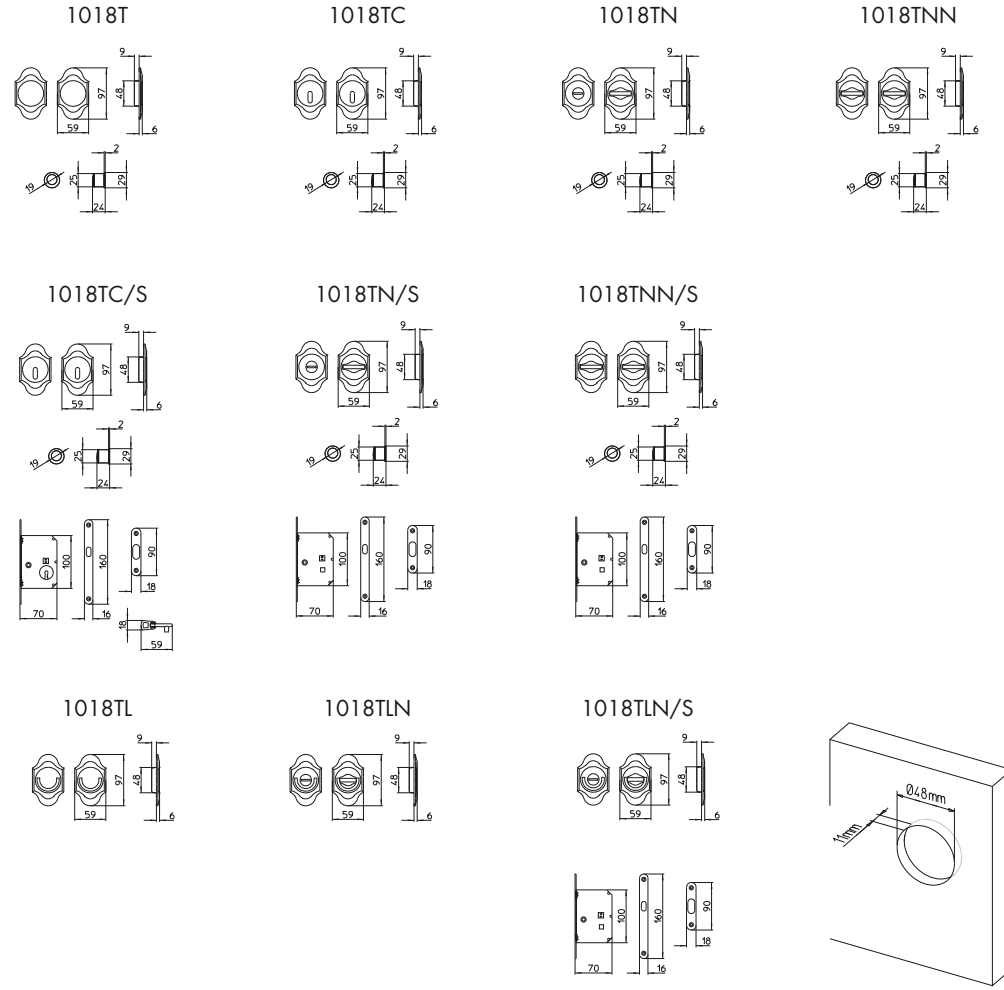

378

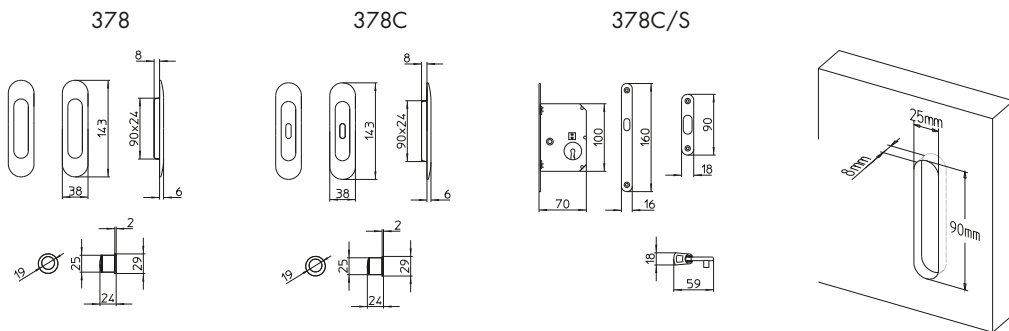

1028 T

1038 T

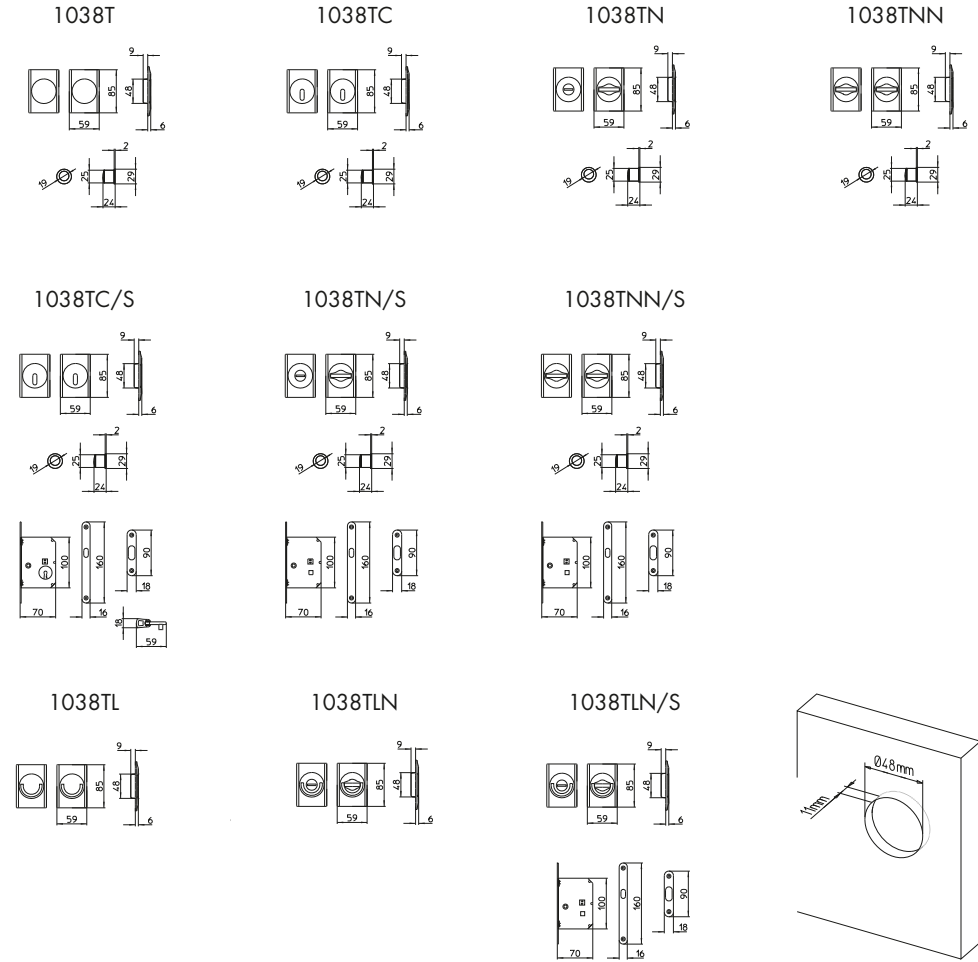
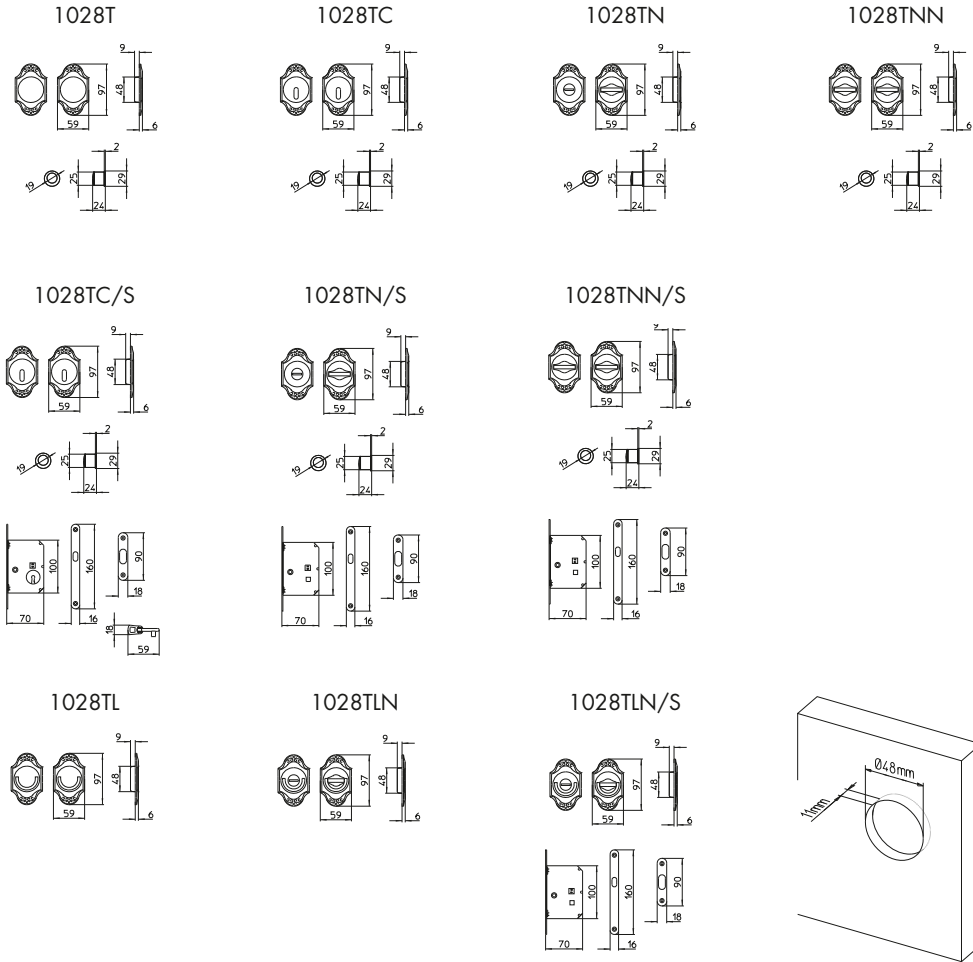

1028

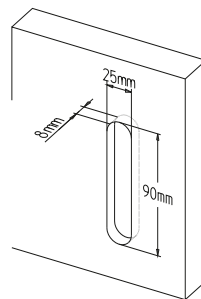
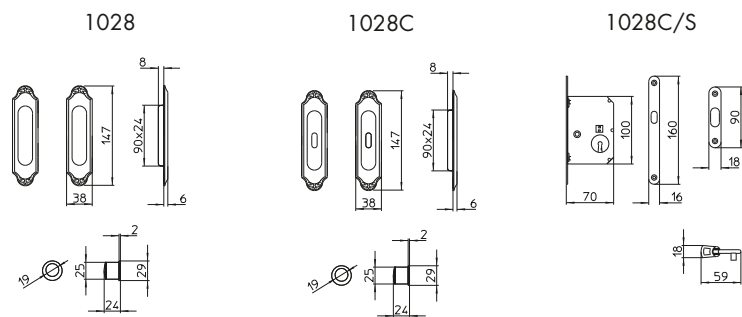

1038

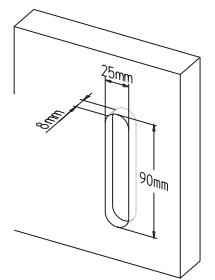
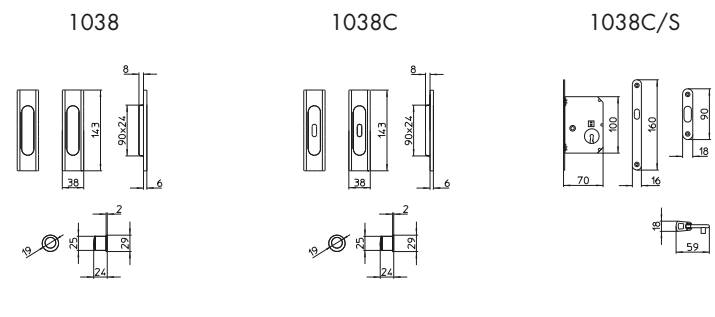

1108 T

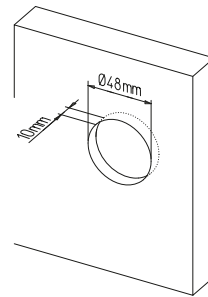
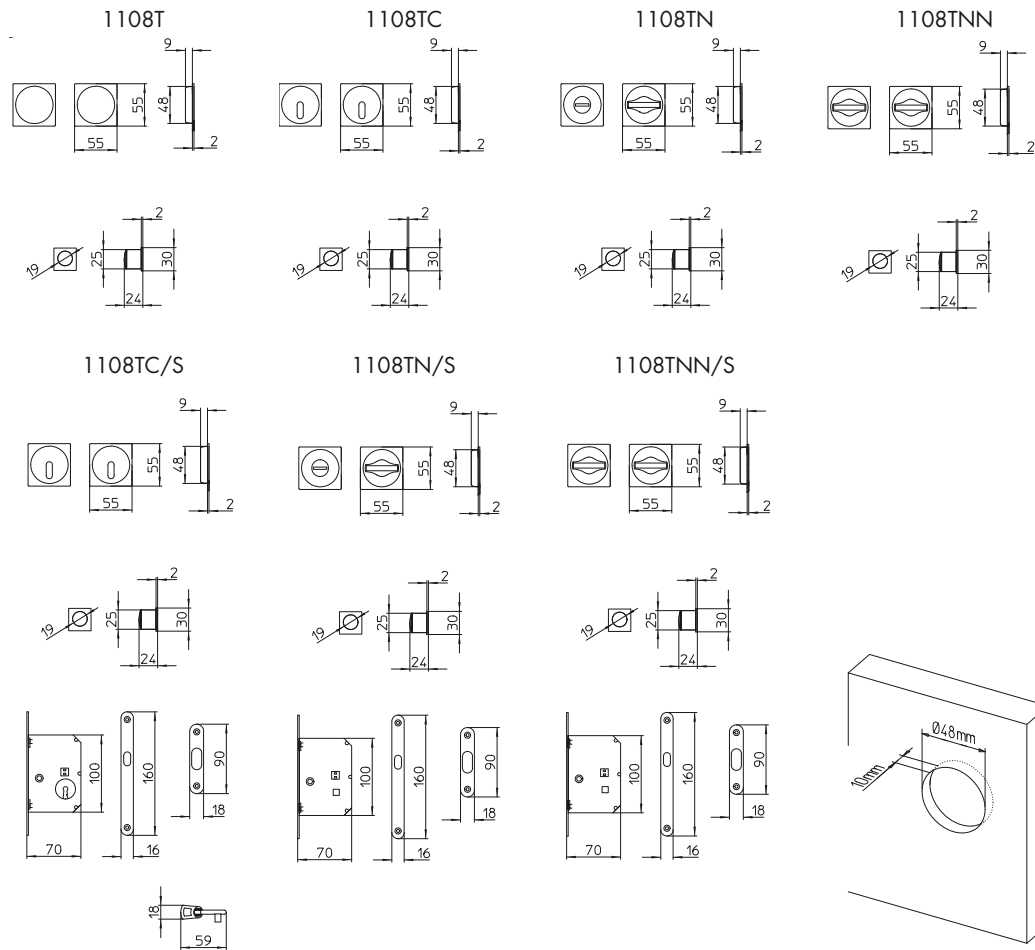

1118 T

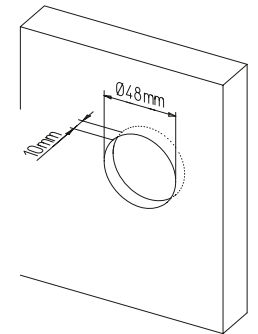
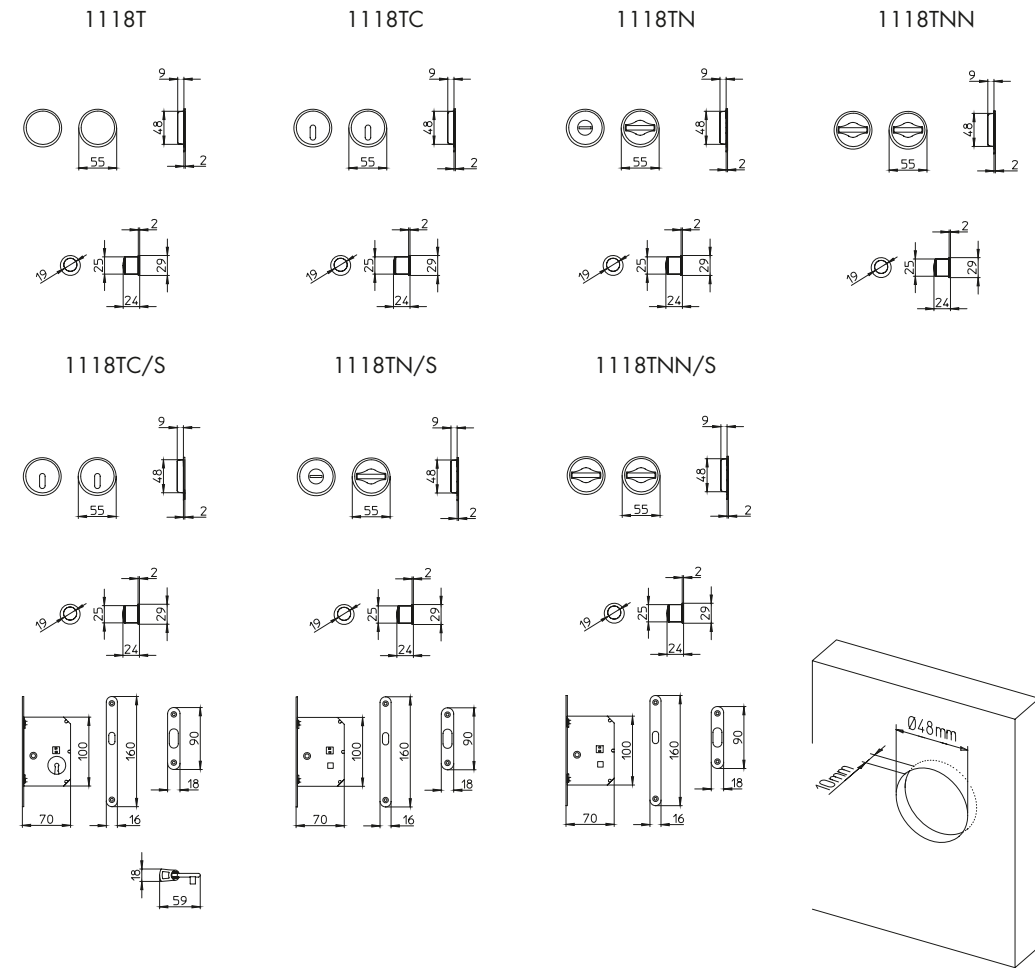

284

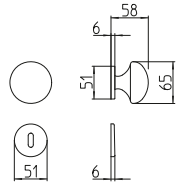

Disponibile anche in versione fissa
/ Also available in a fixed version

644

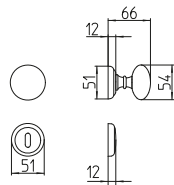

Disponibile anche in versione fissa
/ Also available in a fixed version

744

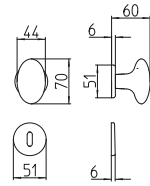

Disponibile anche in versione fissa
/ Also available in a fixed version

651-113



RFV

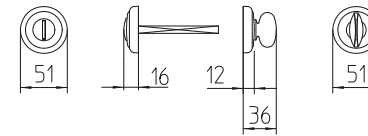

1351-113

RFV-RW

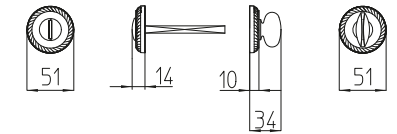

854

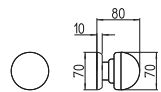

854/GIR

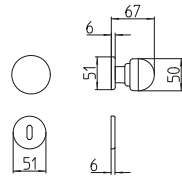

1104

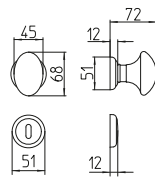

911-114



RFV

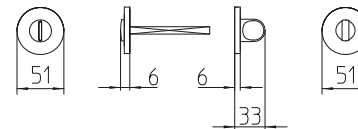

RFV-RW

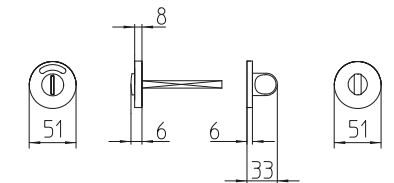

1024/A

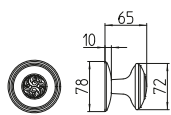

1024/B

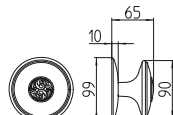

1024/GIR

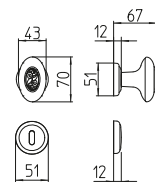

Disponibile anche in versione fissa
/ Also available in a fixed version

1291-115



RFV

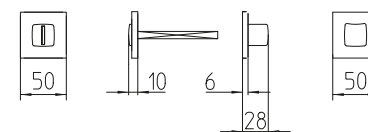

RFV-RW

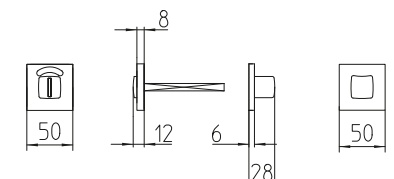

3040

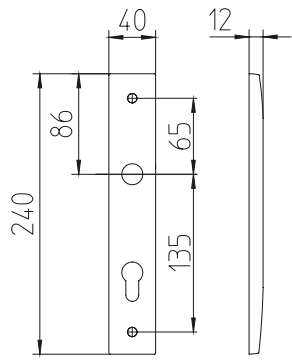

440

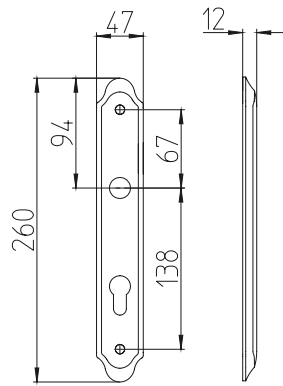

1020

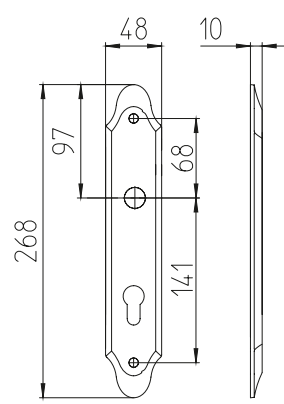

6061

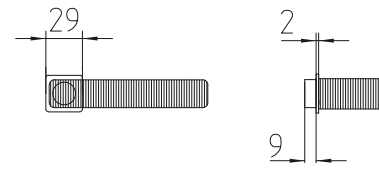

6071

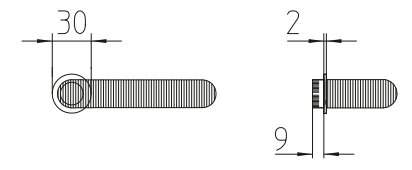

S40

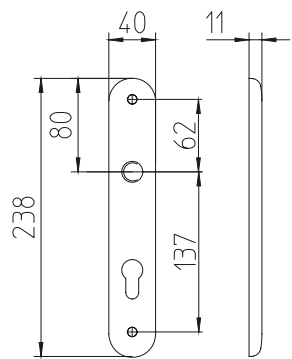

1350

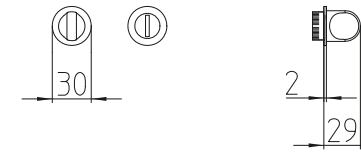
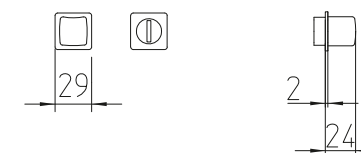
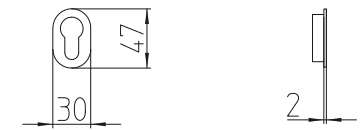
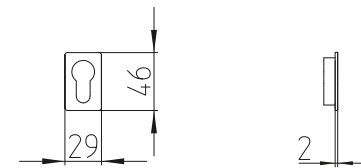
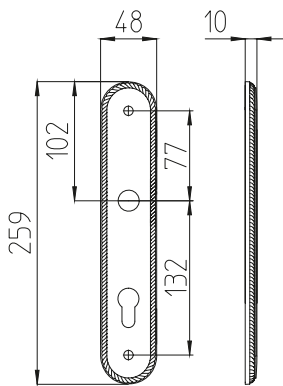

bocchette / escutcheons

651

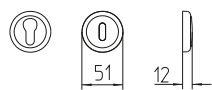

911

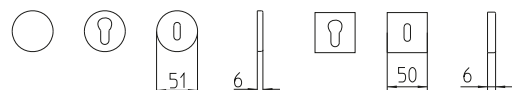

1291

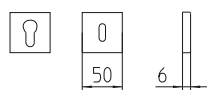

1351

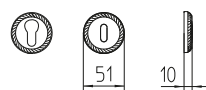

221



BS



BS/Y



231

⊕ PVD



BS

⊕ PVD

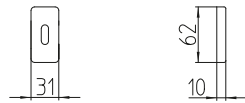

BS/Y

⊕ PVD



VB

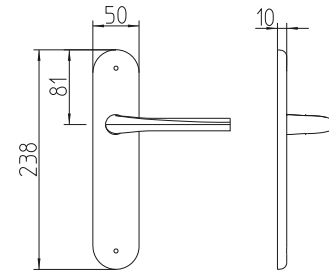

Z

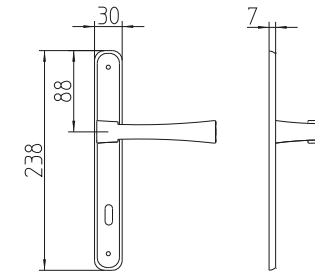

Z/Y

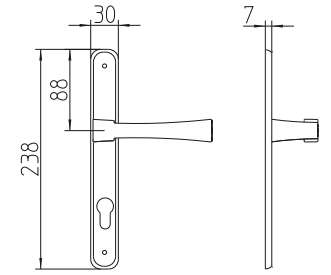

australia

⊕

PRIVACY

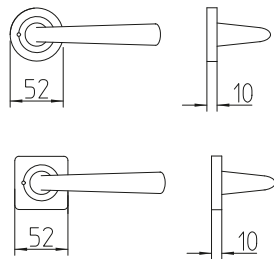

PASSAGE

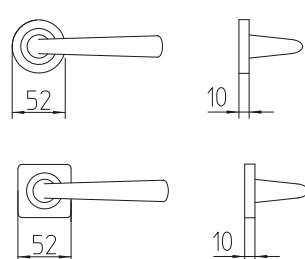

kaba

⊕ PVD

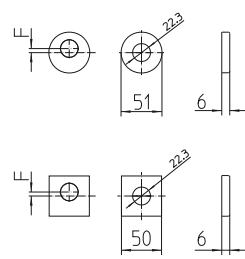

P48

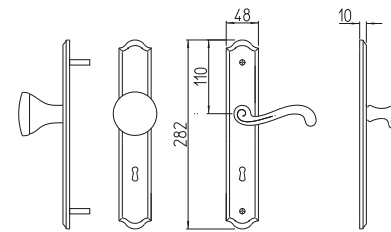

P55

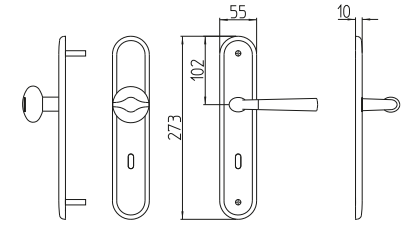

BL1

⊕ PVD

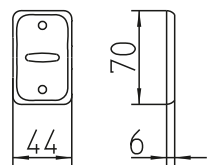

PC1

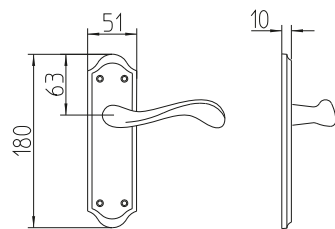

PC2

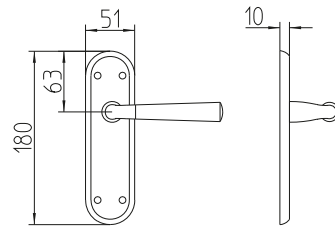

690-SIC

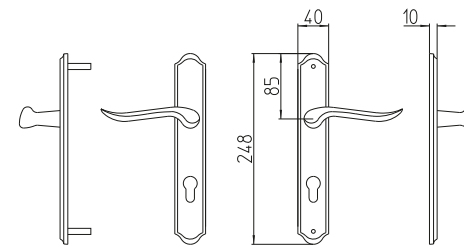

3040-SIC

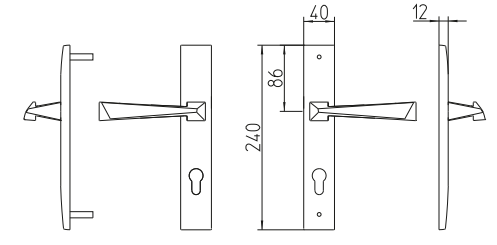

690UP

+ PVD

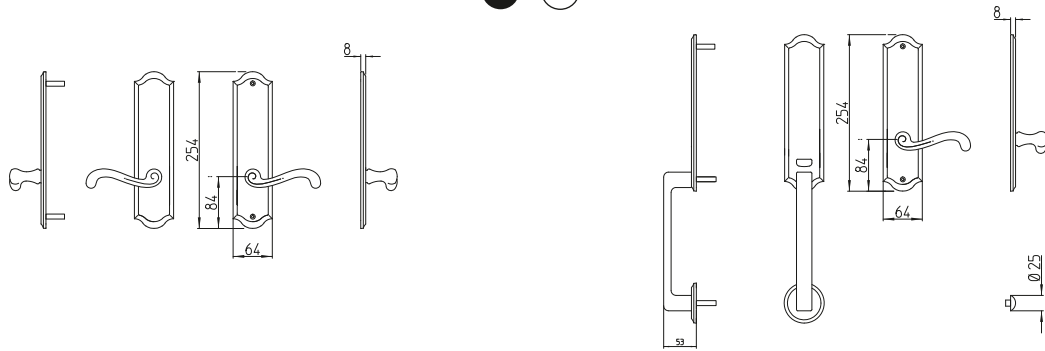

1700UP

+ PVD

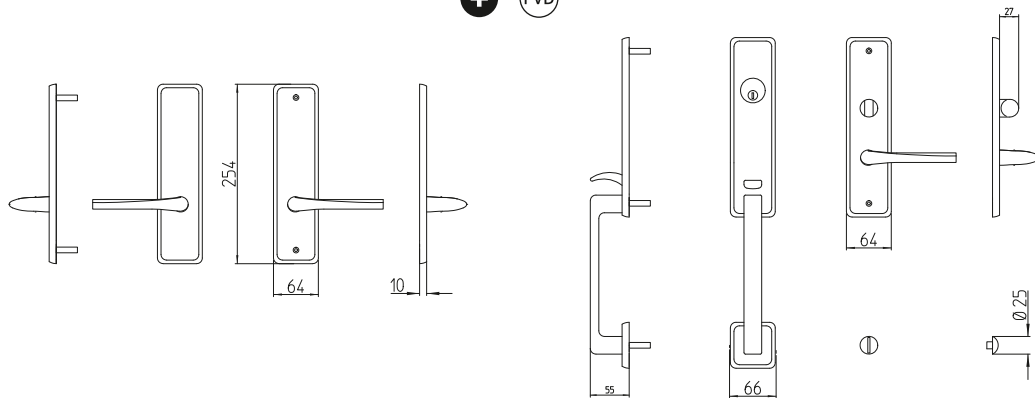

1710UP

+ PVD

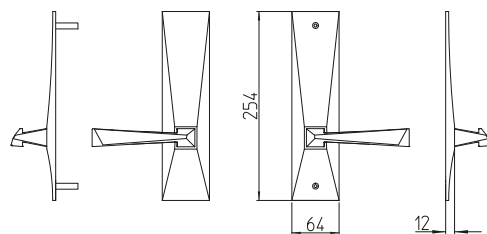

6031US

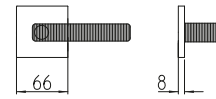

911US

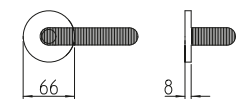

accessori / accessories

200/C

+

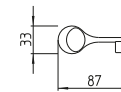

650/C

+

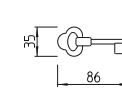

700/C

+

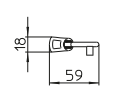

109

+ PVD

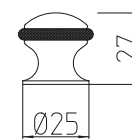

110

+ PVD

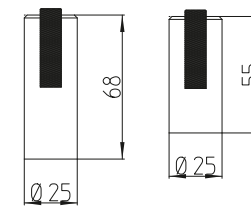

102

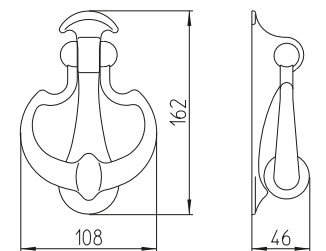

Garanzia. Grazie alla qualità dei materiali impiegati ed all'elevata tecnologia di produzione, MANDELLI1953 offre una speciale garanzia. Il periodo viene esteso, a decorrere dalla data di acquisto, in base alle finiture.

- 26 - 26D: 4 anni;
- Fluxcoating (MBR, AB, 28, MSN): 5 anni;
- PVD: 30 anni.
- La garanzia per i le finiture/materiali non specificati è di 1 Anno
- Avvertenza : Pulire i nostri prodotti solamente con un panno umido d'acqua.

A discrezione di MANDELLI1953, è prevista la riparazione o la sostituzione gratuita del prodotto considerato difettoso entro il periodo di garanzia. Qualora il prodotto sia stato nel frattempo eliminato dalla produzione, MANDELLI1953 potrà, a sua discrezione, decidere se sostituire la merce difettosa con prodotti simili o se rimborsare il costo originario dei prodotti. L'accertamento delle cause, delle responsabilità e la presenza di eventuali vizi di produzione sarà ad insindacabile giudizio di MANDELLI1953. Le spese di invio del campione per tale valutazione sono a carico dell'acquirente. Accertata la responsabilità di MANDELLI1953 e il rispetto dei termini di garanzia, le spese di invio di ulteriore materiale e la restituzione degli stessi riparati o in sostituzione saranno a carico di MANDELLI1953, la stessa non sarà in alcun caso responsabile per i costi relativi all'installazione, riparazione e sostituzione come di danni o perdite lamentate.

Guarantee. The high quality of the technology and production processes means that MANDELLI1953 offers special guarantees. The extended guarantee period runs from the date of purchase, the term depending on the type of finish.

- 26 - 26D: 4 years;
- Fluxcoating (MBR, AB, 28, MSN): 5 years;
- PVD: 30 years.
- The warranty for non-specified finishes / materials is 1 year
- Warning: Clean our products only with a damp cloth.

The guarantee provides, at the discretion of MANDELLI1953, for repairs to or the free replacement of the product deemed defective within the guarantee period. If the product has in the meantime gone out of production, MANDELLI1953 may, at its discretion, decide to replace the defective goods with similar products, or to reimburse the customer the original cost. Ascertaining the causes of, responsibility for and the presence of any production process defects, are matters for the final judgement of MANDELLI1953. The costs of sending the sample for appraisal shall be borne by the purchaser. When the responsibility of MANDELLI1953 has been ascertained and the guarantee terms are complied with, the costs of sending any further goods and the return of repaired good or replacement goods shall be borne by MANDELLI1953, while the company shall in no case be liable for costs relating to installation, repair or replacement or for damages or losses complained of.



































DK di sicurezza MANDELLI1953 propone, su tutti i modelli di maniglie per porte e maniglie DK , rosette e bocchette elegantemente sottili dello spessore di soli 6mm e senza necessità di lavorazioni aggiuntive. In ogni maniglia MANDELLI1953, il movimento delle martelline è composto esclusivamente da elementi metallici; le parti mobili sono rivestite da una particolare nichelatura antifrizione uniforme, resistente ad usura e corrosione. Il movimento è stato testato nei nostri laboratori, con i criteri della norma RAL-RG 607/9. La norma prevede almeno 10.000 cicli di utilizzo: le nostre martelline hanno superato i 16.000 cicli, paragonabili ad oltre 10 anni di utilizzo.

Security DK Lever System MANDELLI1953 proposes, on all models, the new lowered mechanism for the DK system (6mm). As with all MANDELLI1953 handles the mechanism is entirely made up of metal components. The moving parts have a special nickel coating that creates a uniform friction-free layer that is resistant to wear and corrosion. The movement was laboratory tested according to RAL-RG 607/9, and while the standard provides for at least 10.000 turns, the MANDELLI1953 handles were subject to over 16.000 turns, equivalent to over 10 years' normal usage.



Componenti Flat MANDELLI1953 propone, su tutti i modelli di maniglie per porte e maniglie DK , rosette e bocchette elegantemente sottili dello spessore di soli 6mm e senza necessità di lavorazioni aggiuntive. In ogni maniglia MANDELLI1953, il movimento delle martelline è composto esclusivamente da elementi metallici; le parti mobili sono rivestite da una particolare nichelatura antifrizione uniforme, resistente ad usura e corrosione. Il movimento è stato testato nei nostri laboratori, con i criteri della norma RAL-RG 607/9. La norma prevede almeno 10.000 cicli di utilizzo: le nostre martelline hanno superato i 16.000 cicli, paragonabili ad oltre 10 anni di utilizzo.

Flat Components MANDELLI1953 proposes, on all models, the new lowered mechanism for the DK system (6mm). As with all MANDELLI1953 handles the mechanism is entirely made up of metal components. The moving parts have a special nickel coating that creates a uniform friction-free layer that is resistant to wear and corrosion. The movement was laboratory tested according to RAL-RG 607/9, and while the standard provides for at least 10.000 turns, the MANDELLI1953 handles were subject to over 16.000 turns, equivalent to over 10 years' normal usage.

	40+1_1831 contemporary	54		FENIX_1601 contemporary	80
	ANDE_451 contemporary	56		FILO_721 contemporary	82
	AQUALUNG_1791 contemporary	58		FRAME_1870 contemporary	84
	ARA_3191 contemporary	60		FUSILLA_ contemporary	86
	ARIES_307 contemporary	62		GOU_1421 classic	162
	ASTRID_1631 contemporary	64		GRINT_1751 contemporary	88
	AURORA_1511 classic	156		HARTÙ_1341 classic	164
	BILBAO_1671 contemporary	66		ISI_1081 contemporary	90
	BIX_1141 contemporary	68		JET_1371 contemporary	92
	CALLAS_1611 contemporary	70		JUNO_8021 contemporary	94
	CARRÉ_1621 contemporary	72		K_1950 contemporary	96
	CHIO_1181 contemporary	74		KIRI_1461 contemporary	98
	COCÒ_1641 classic	158		KUKI_1741 contemporary	100
	DEMÍ_3181 contemporary	76		LARIO_1681 contemporary	102
	DOGE_641 contemporary	160		LED_1091 contemporary	104
	FAN_1291 contemporary	78		LIFE_1171 contemporary	106

	LINK_1031 contemporary	108		SEVEN_1761 contemporary	124
	LORD_1021 classic	166		SEVILLA_531 classic	182
	MELODY_1201 classic	168		SPECIAL_S90 contemporary	126
	MITOS_1131 contemporary	110		SPIN_731 contemporary	128
	MM80_080 contemporary	112		START_S101 contemporary	130
	NADIR_771 contemporary	114		TELIS_1161 contemporary	132
	NAXOS_8011 classic	170		TOTEM_461 contemporary	134
	NORMA_1211 classic	172		TUC_361 contemporary	136
	NURIA_1501 contemporary	116		TWEE_1691 contemporary	138
	OLA_1071 contemporary	118		VIRGO_1650 contemporary	140
	PAROS_8001 classic	174		ZANTE_1301 contemporary	142
	PIRAMID_1251 contemporary	120		ZEIT_1721 contemporary	144
	PLISSÉ_981 classic	176		ZEN_711 contemporary	146
	PP33_033 contemporary	122		ZOE_381 contemporary	148
	RIVER_991 classic	178		ZOOM_351 contemporary	150
	RONDÒ_691 classic	180			

	033_PP33 contemporary	122		991_RIVER classic	178
	080_MM80 contemporary	112		1021_LORD classic	166
	307_ARIES contemporary	62		1031_LINK contemporary	108
	351_ZOOM contemporary	150		1071_OLA contemporary	118
	361_TUC contemporary	136		1081_ISI contemporary	90
	381_ZOE contemporary	148		1091_LED contemporary	104
	451_ANDE contemporary	56		1131_MITOS contemporary	110
	461_TOTEM contemporary	134		1141_BIX contemporary	68
	531_SEVILLA classic	182		1161_TELIS contemporary	132
	641_DOGE classic	160		1171_LIFE contemporary	106
	691_RONDÒ classic	180		1181_CHIO contemporary	74
	711_ZEN contemporary	146		1201_MELODY classic	168
	721_FILO contemporary	82		1211_NORMA classic	172
	731_SPIN contemporary	72		1251_PIRAMID contemporary	120
	771_NADIR contemporary	128		1291_FAN contemporary	78
	981_PLISSÉ classic	176		1301_ZANTE contemporary	142

	1341_HARTÙ classic	164		1730_FUSILLA contemporary	86
	1371_JET contemporary	92		1740_KUKI contemporary	100
	1421_GOU classic	162		1750_GRINT contemporary	88
	1461_KIRI contemporary	98		1760_SEVEN contemporary	124
	1501_NURIA contemporary	116		1790_AQUALUNG contemporary	58
	1511_AURORA classic	156		1831_40+1 contemporary	54
	1601_FENIX contemporary	80		1870_FRAME contemporary	84
	1611_CALLAS contemporary	70		1950_K contemporary	96
	1621_CARRÉ contemporary	72		3181_DEMÍ contemporary	76
	1631_ASTRID contemporary	146		3191_ARA contemporary	60
	1641_COCÒ classic	158		8001_PAROS classic	174
	1650_VIRGO contemporary	140		8011_NAXOS classic	170
	1671_BILBAO contemporary	66		8020_JUNO contemporary	94
	1681_LARIO contemporary	102		S91_SPECIAL contemporary	126
	1691_TWEE contemporary	138		S101_START contemporary	130
	1720_ZEIT contemporary	144			

Il catalogo e i prodotti sono soggetti ad aggiornamenti.

Le colorazioni e le raffigurazioni visibili sul catalogo hanno valore puramente indicativo e possono presentare leggere differenze dal prodotto originale in quanto riportate con un procedimento di stampa.

Eventuali discordanze tra prodotto finito e rappresentazione non costituiscono motivo di reclamo, essendo l'ordine effettuato l'unico parametro di riferimento.

Le quote riportate sono indicative e potrebbero avere lievi differenze date dal fatto che le nostre lavorazioni sono realizzate a mano.

Modelli e marchi depositati.

Tutti i diritti riservati © ERCO srl.

Catalogues and products are subject to improvements.

Colors and pictures in the catalogue are not binding and may slightly differ if compared with the true product since they are obtained by a printing process.

Possible differences between ready-made product and its representation cannot cause any complaint, since the purchase order is the only binding reference document.

The amounts reported are indicative and may slightly vary due to the fact that our machining operations are performed manually.

Models are trade-marks registered.

All rights reserved © ERCO srl.

MANDELLI 1953
via Canturina Vecchia, 13
22070 Senna Comasco (CO) Italy
T. +39 0362 96991
F. +39 0362 969920
info@mandelli.it

mandelli.it

